



The **VORTEX** team



- **U. Liège:** O. Absil, J. Surdej, S. Habraken, M. Van Droogenbroeck, D. Defrère, C. Delacroix, G. Orban de Xivry, M. Reggiani, O. Wertz, B. Carlomagno, V. Christiaens, C. Gomez Gonzalez, A. Jolivet
- **U. Uppsala:** M. Karlsson, P. Forsberg, P. Piron, E. Vargas Catalan
- **Caltech/JPL:** D. Mawet, E. Serabyn, K. Matthews, G. Ruane, AJ Riggs, E. Choquet, M. Bottom, H. Ngo, R. Jensen-Clem
- **Obs. Paris:** E. Huby, P. Baudoz
- Collaborators at *ESO* (J. Girard, J. Milli, M. Kasper, H.-U. Käufel), *CEA Saclay* (E. Pantin), *U. Leiden* (M. Kenworthy, F. Snik), *Keck* (B. Femenia, P. Wizinowich), *U. Arizona* (P. Hinz)

OLIVIER ABSIL

FIVE YEARS OF HARVEST WITH THE VORTEX CORONAGRAPH

OUTLINE

history and technology development

commissioning & on-sky performance

scientific results

image processing with machine learning

future projects



HISTORY AND TECHNOLOGY DEVELOPMENT

THE BIRTH OF A CONCEPT

► FQPM → sub-wavelength grating → annular groove phase mask

Rouan et al. (2000)

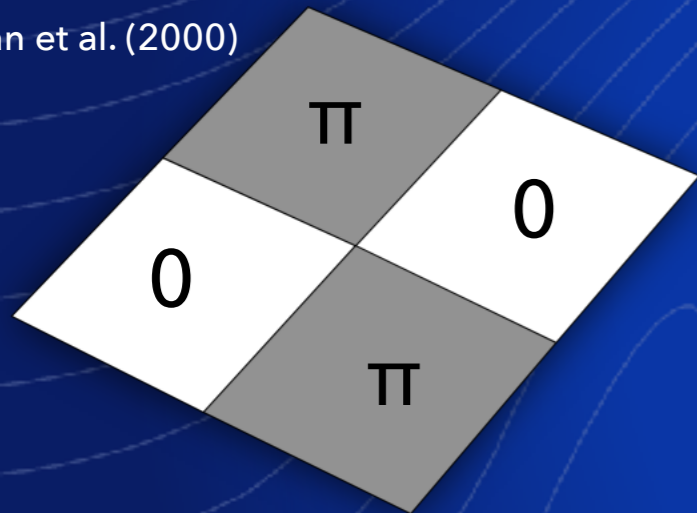

2003

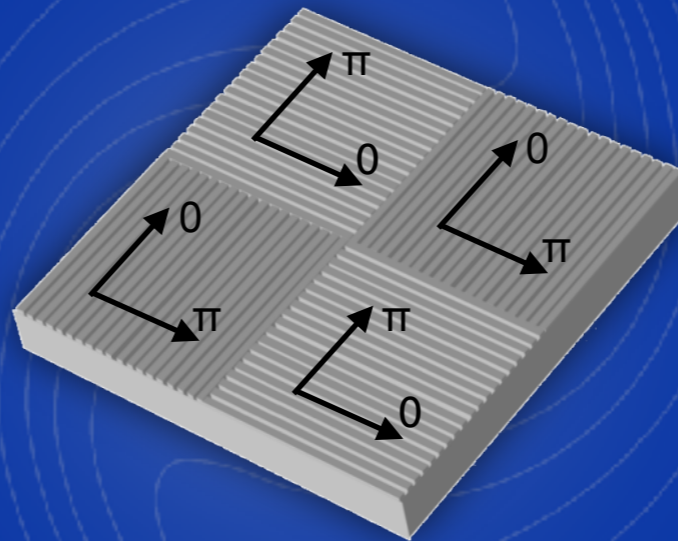

2005



Mawet et al. (2005)

► advantages:

- * inner working angle
- * clear 360° discovery space
- * achromaticity

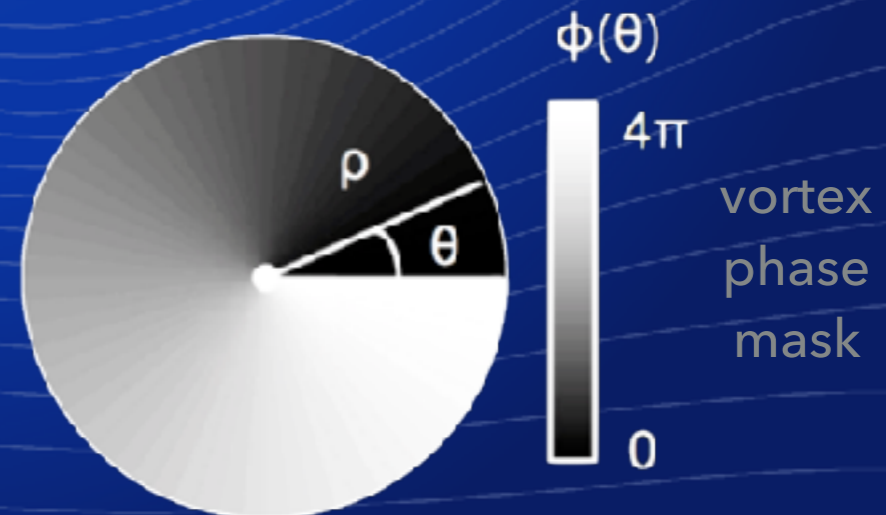

THE VORTEX CORONAGRAPH IN A NUTSHELL

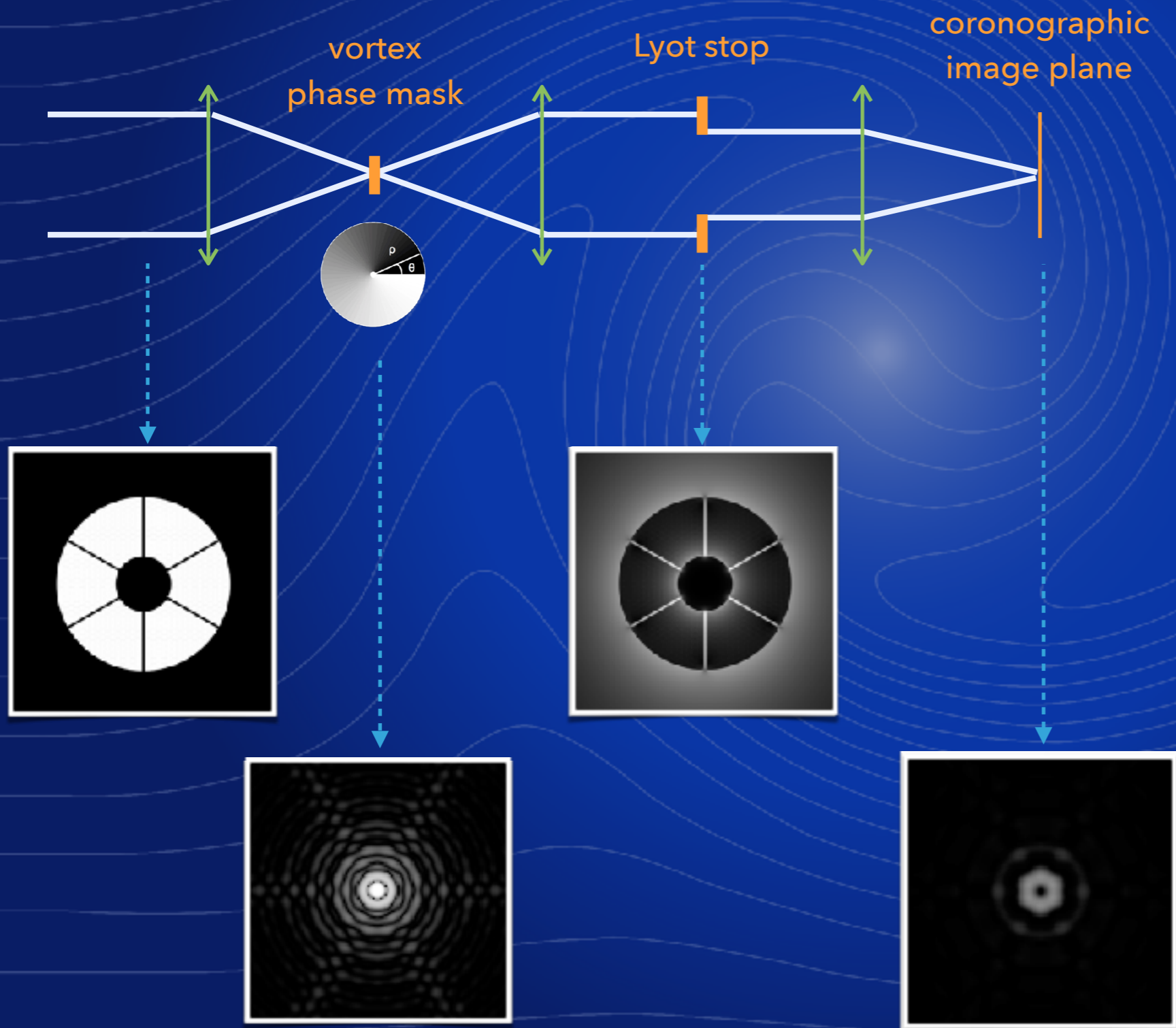

perfect on-axis cancellation
for a circular aperture

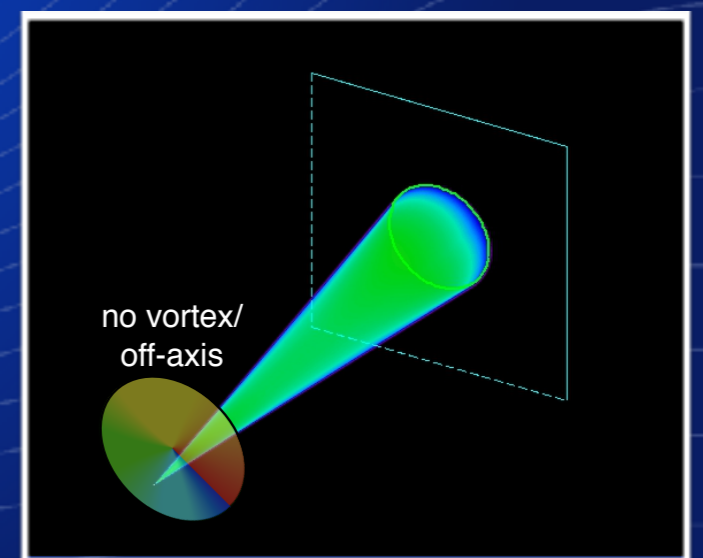
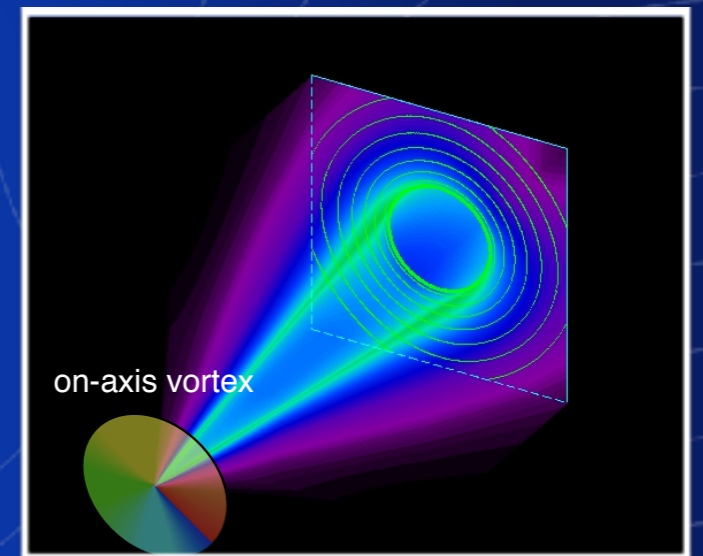

IMPLEMENTATIONS OF THE VORTEX PHASE MASK

▶ scalar vortex

- * helical piece of glass

▶ vector vortex

- * liquid crystal polymers
- * subwavelength gratings
- * photonic crystals

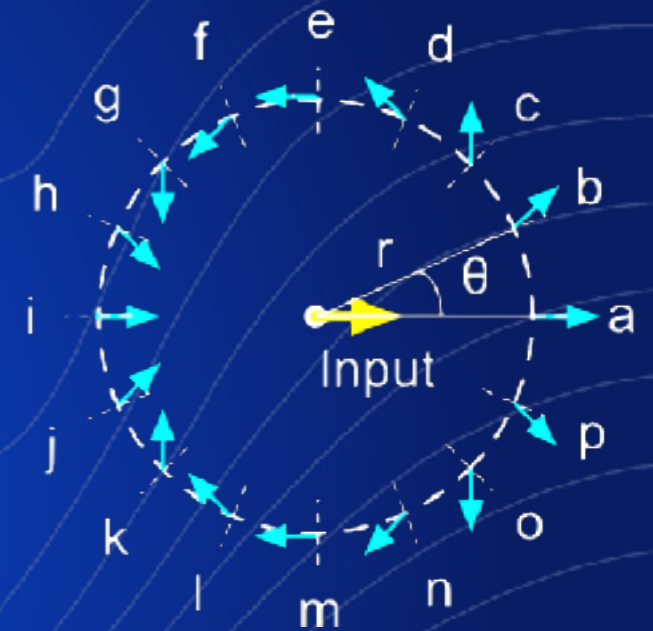
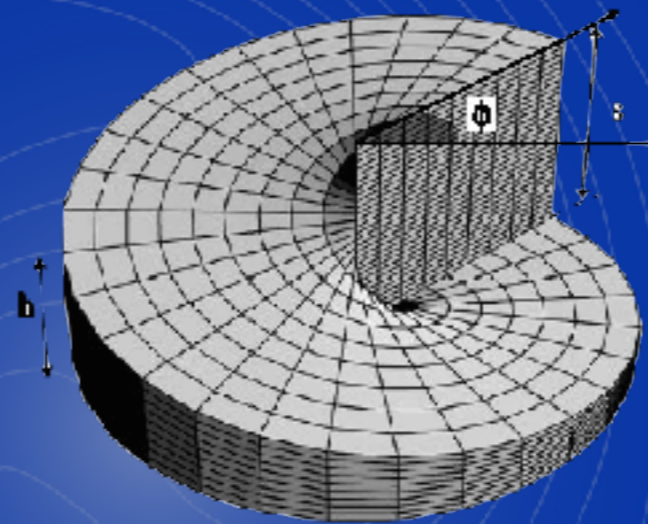

Annular Groove Phase Mask



OPTIMIZING THE GRATING DESIGN

L band. Period = $1.42 \mu\text{m}$, angle = 3.00°

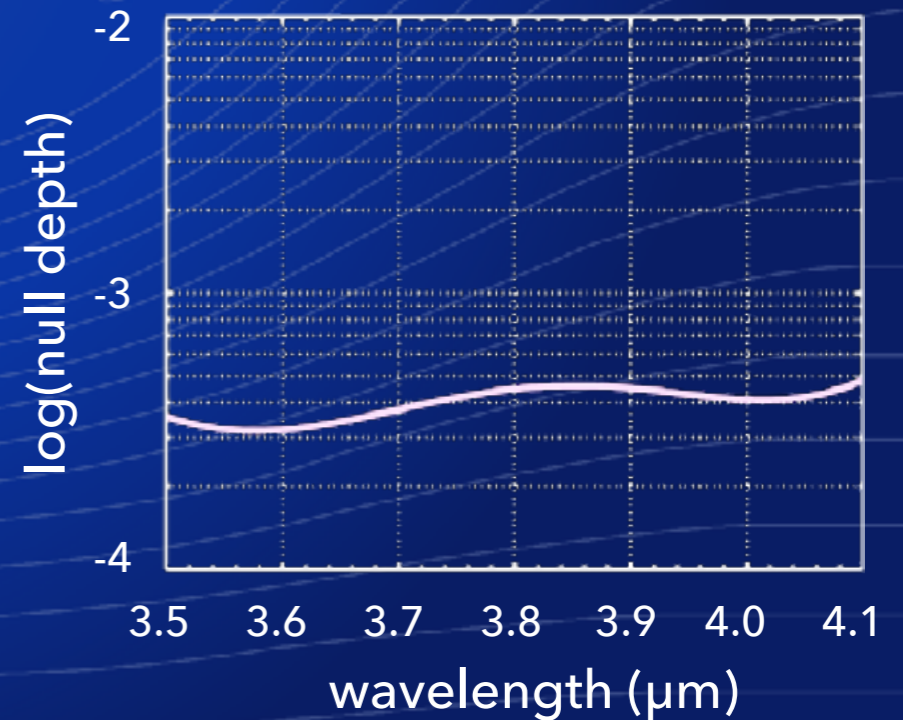
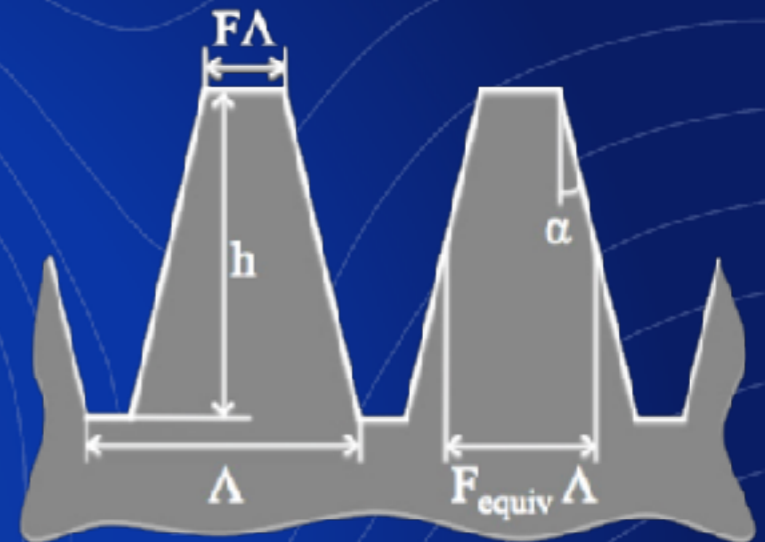
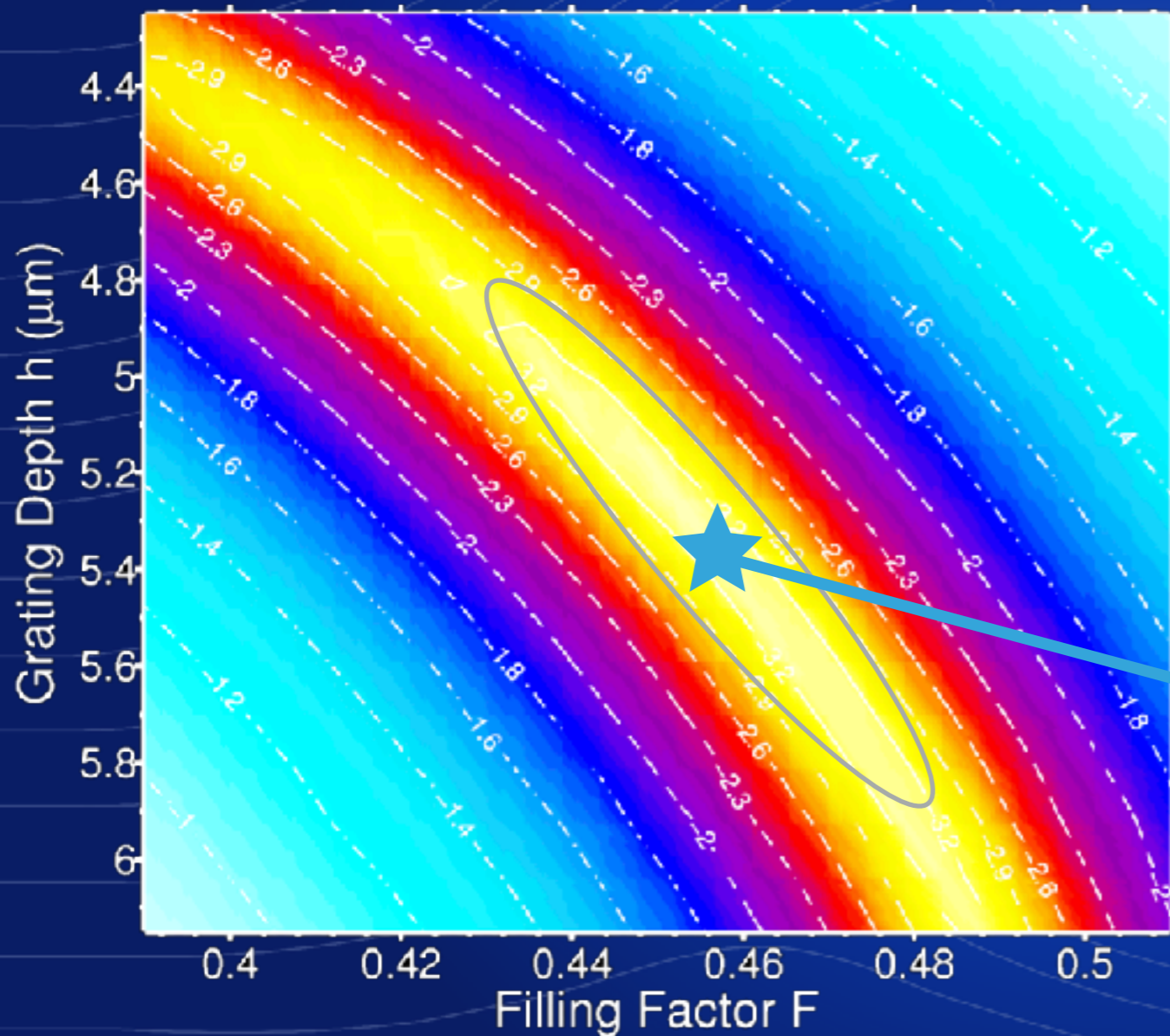

MANUFACTURING DIAMOND AGPM @ UPPSALA

Vargas Catalan et al. (2016)

1. diamond coated with Al and Si layers (sputtering)

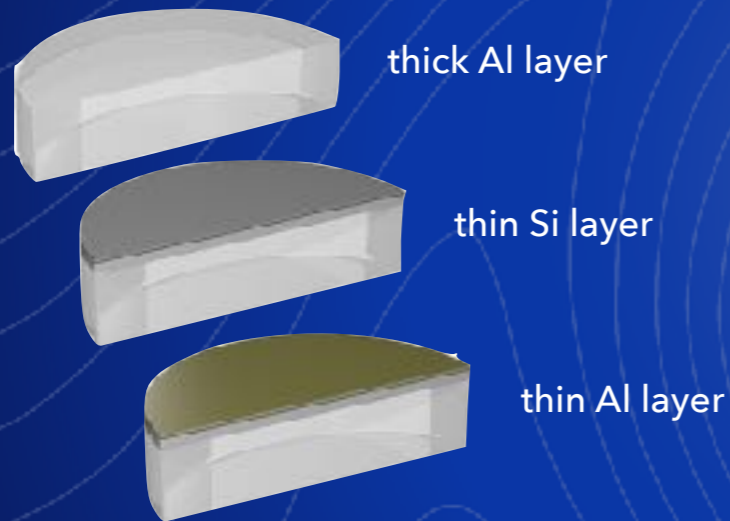

2. e-beam pattern transferred with solvent-assisted moulding

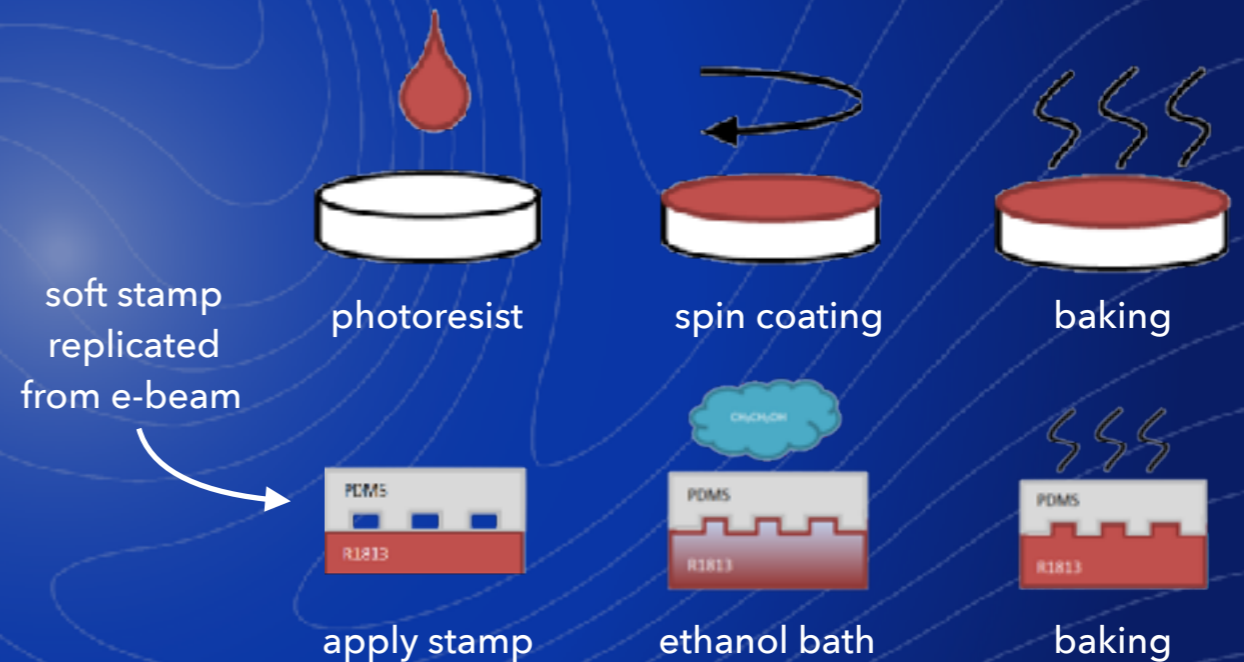

3. reactive ion etching

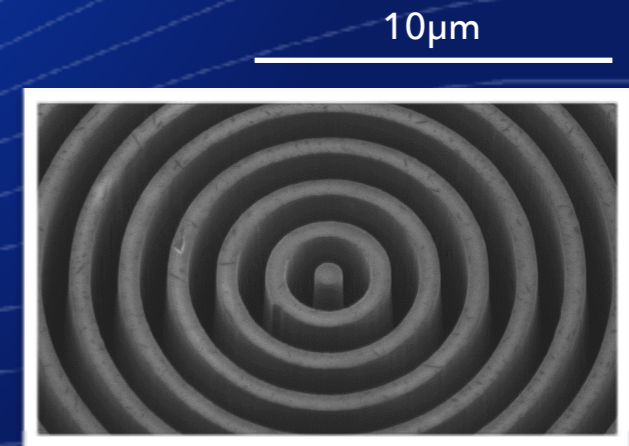
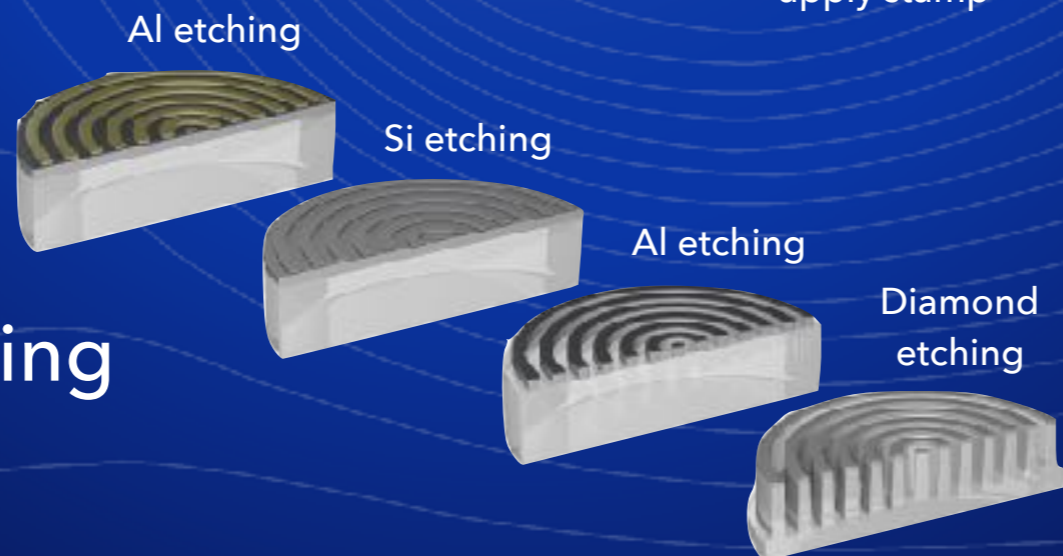

SETTING UP THE « YACADIRE » BENCH @ MEUDON

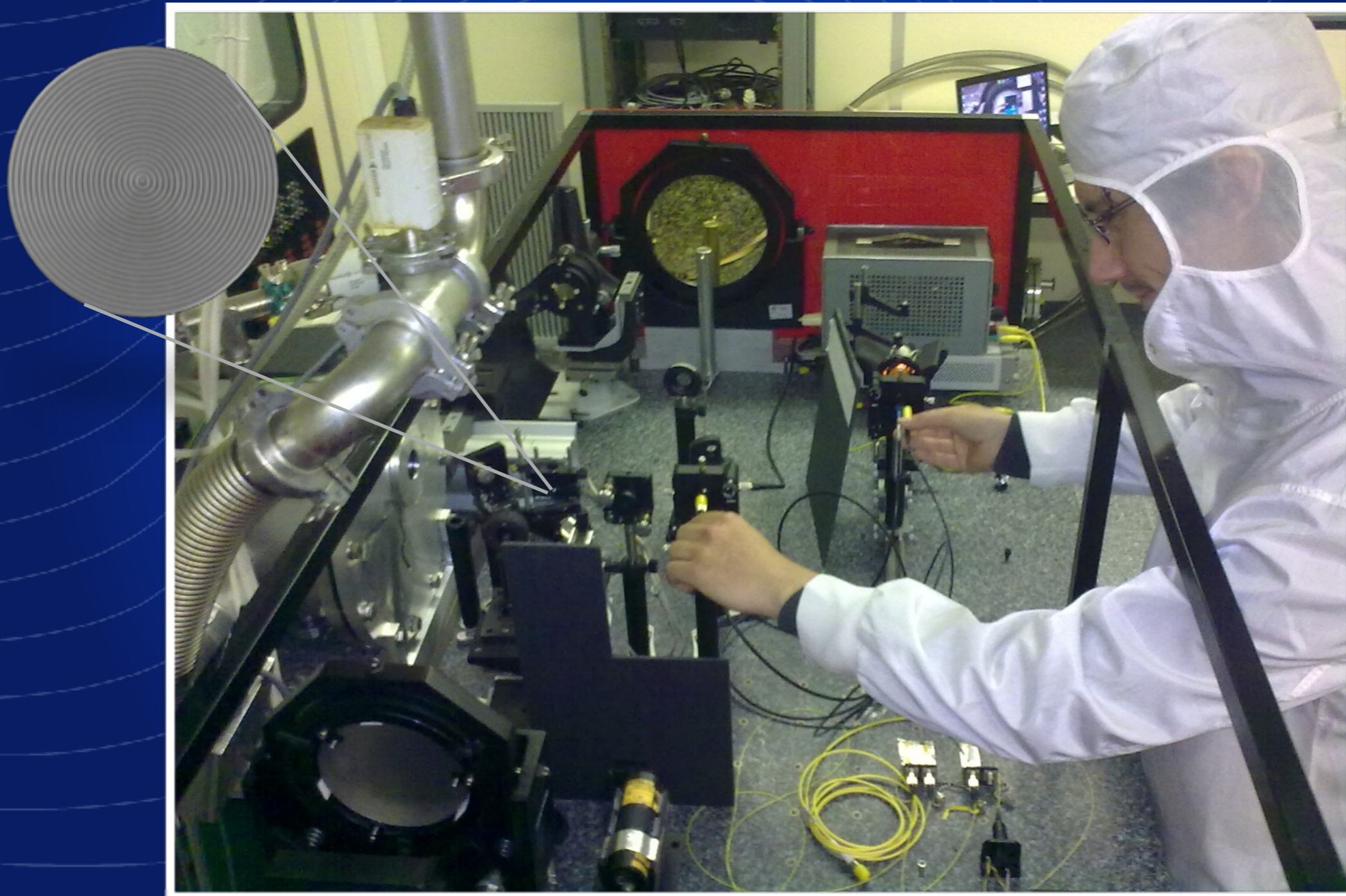

ANGUISH...

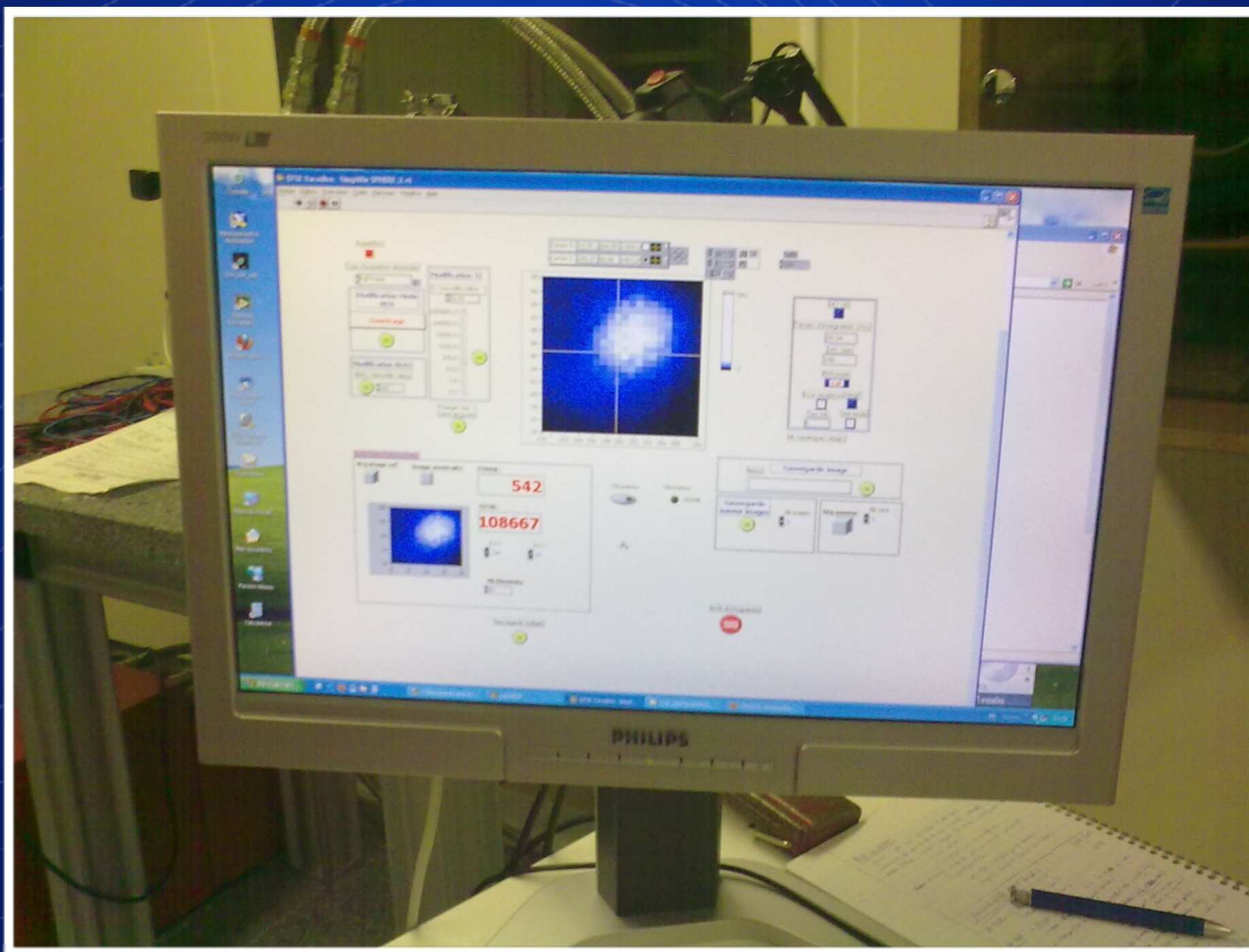

AFTER SOME TUNING...

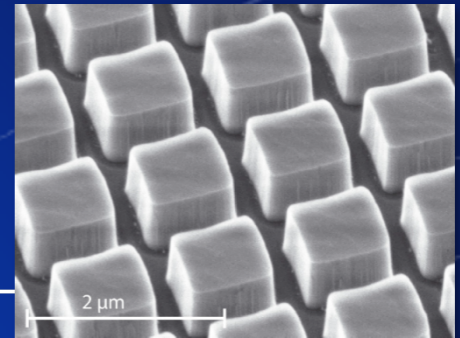
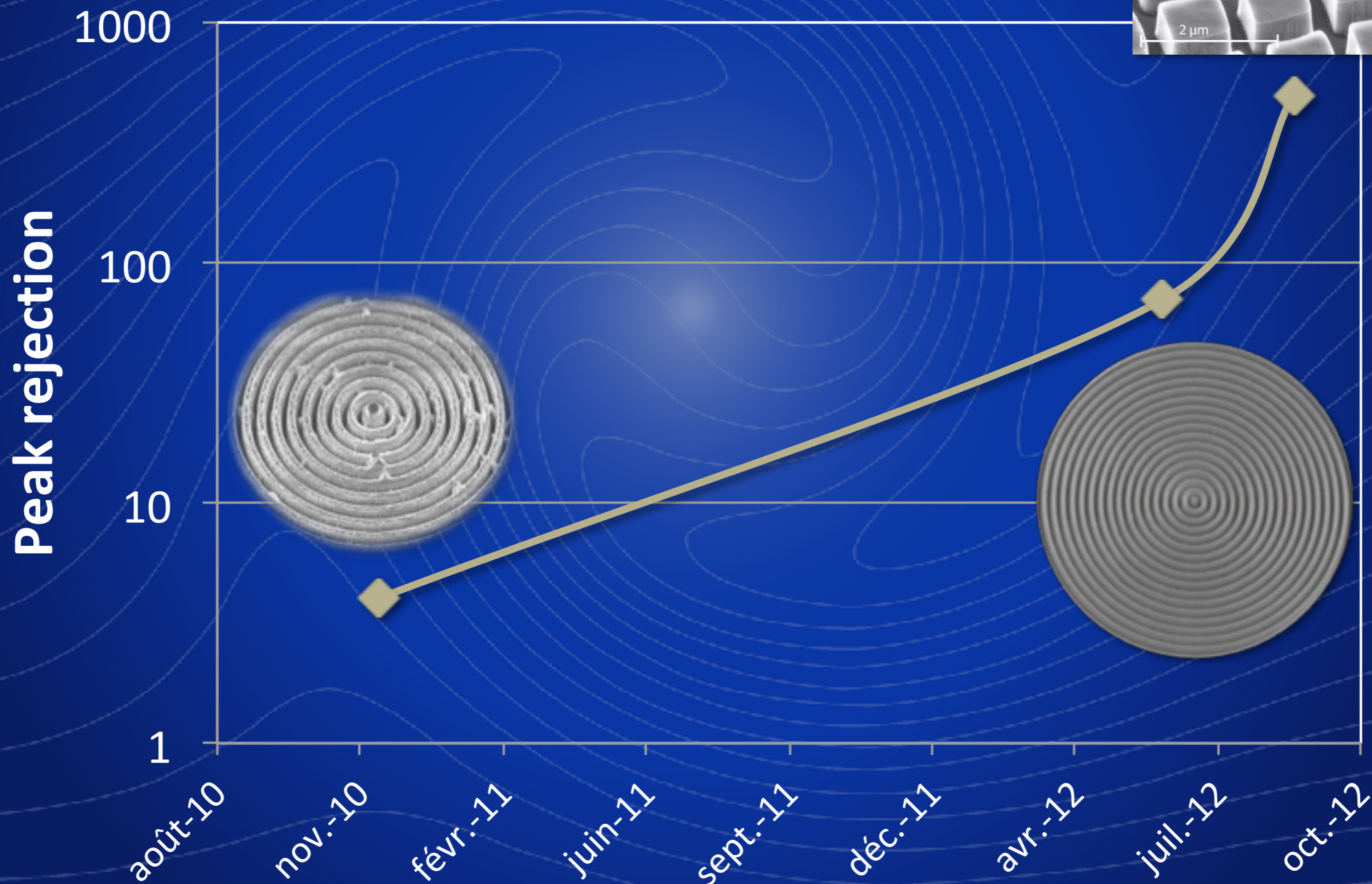

BLISS!

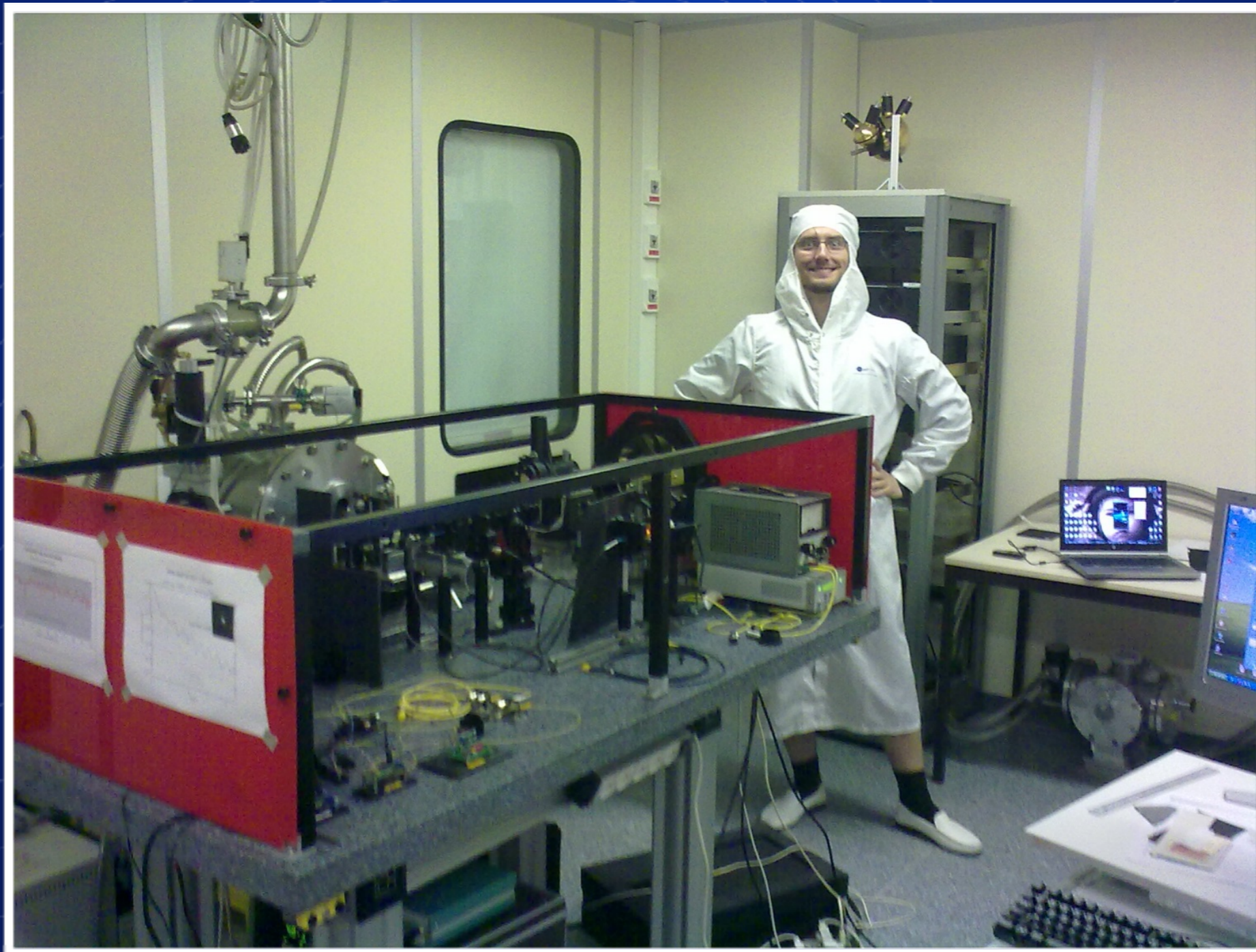

BEST PERFORMANCE IN THE LAB - 2017 UPDATE

- ▶ dedicated test bench (VODCA) now available at ULiège
- ▶ 10+ science-grade L-band AGPMs etched & tested
- ▶ broadband rejection up to 1500 : 1

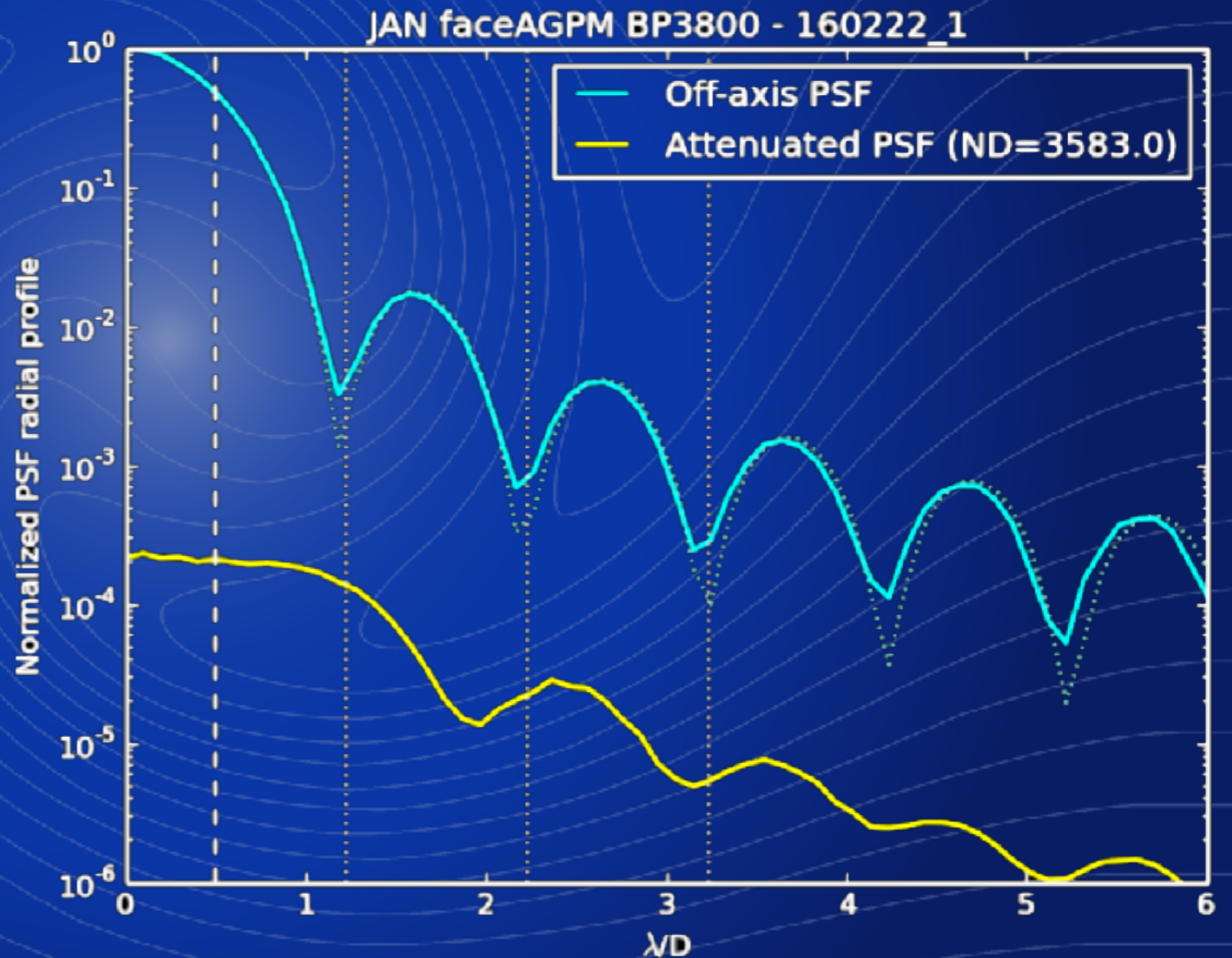

EXTENDING THE CONCEPT

- ▶ AGPM first developed for thermal infrared (L, M, N bands)
 - * excellent performance on ~30% bandwidth
- ▶ manufacturing tests for H-K bands promising, but work remains to be done
- ▶ now exploring higher topological charges
 - * less sensitive to tip-tilt, at the expense of larger IWA

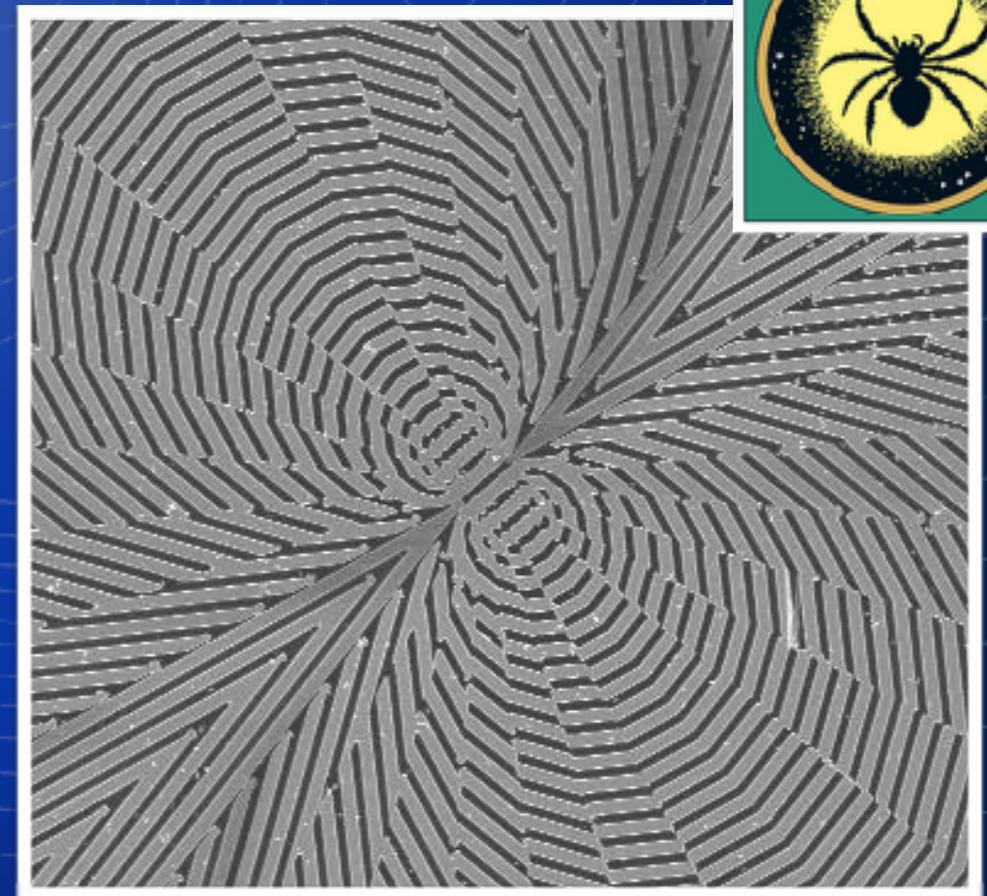

work in progress



COMMISSIONING & ON-SKY PERFORMANCE

INSTALLATION AND COMMISSIONING

- ▶ piggyback on existing coronagraphic IR cameras
- ▶ very short commissioning phase (1-2 nights)

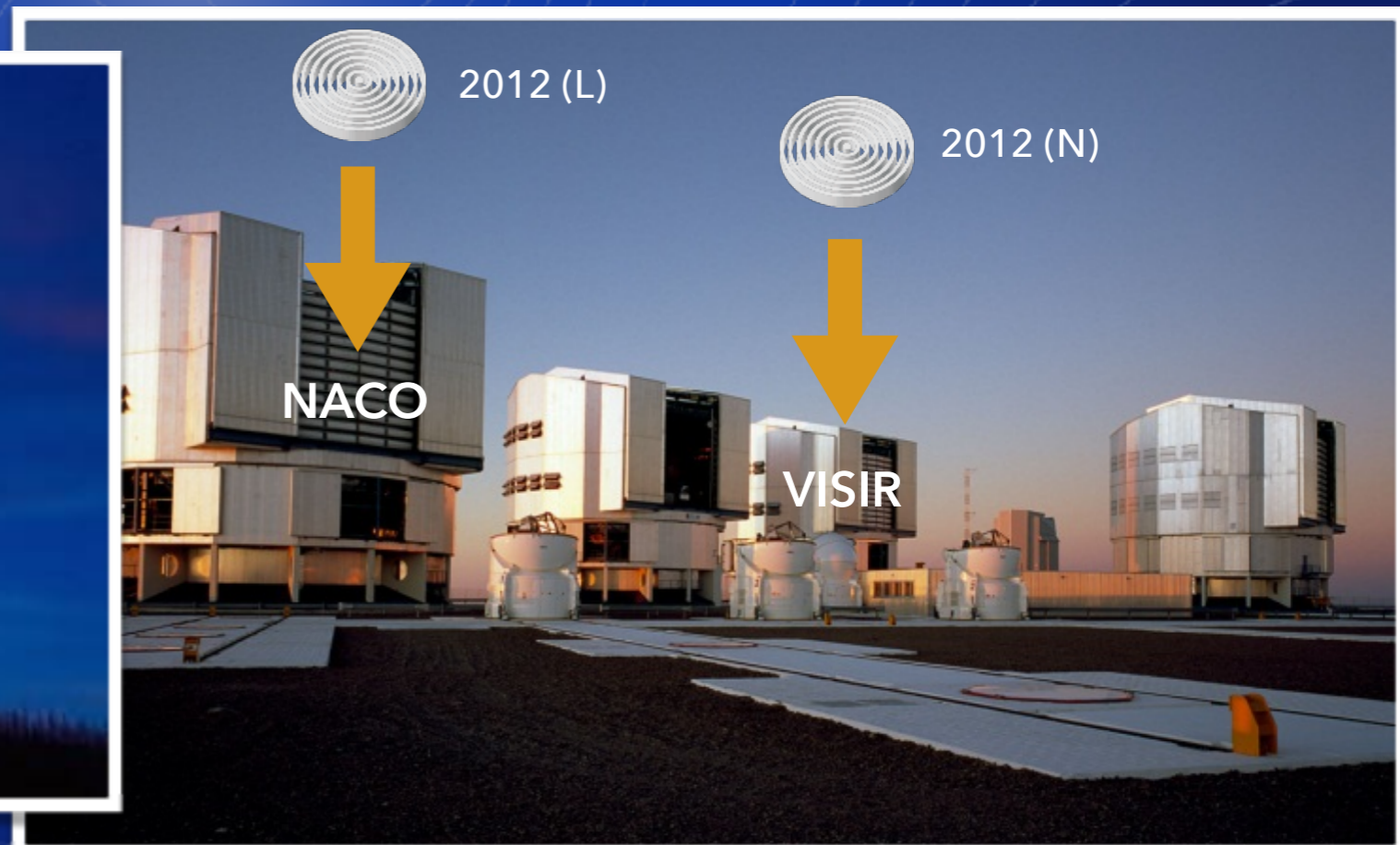
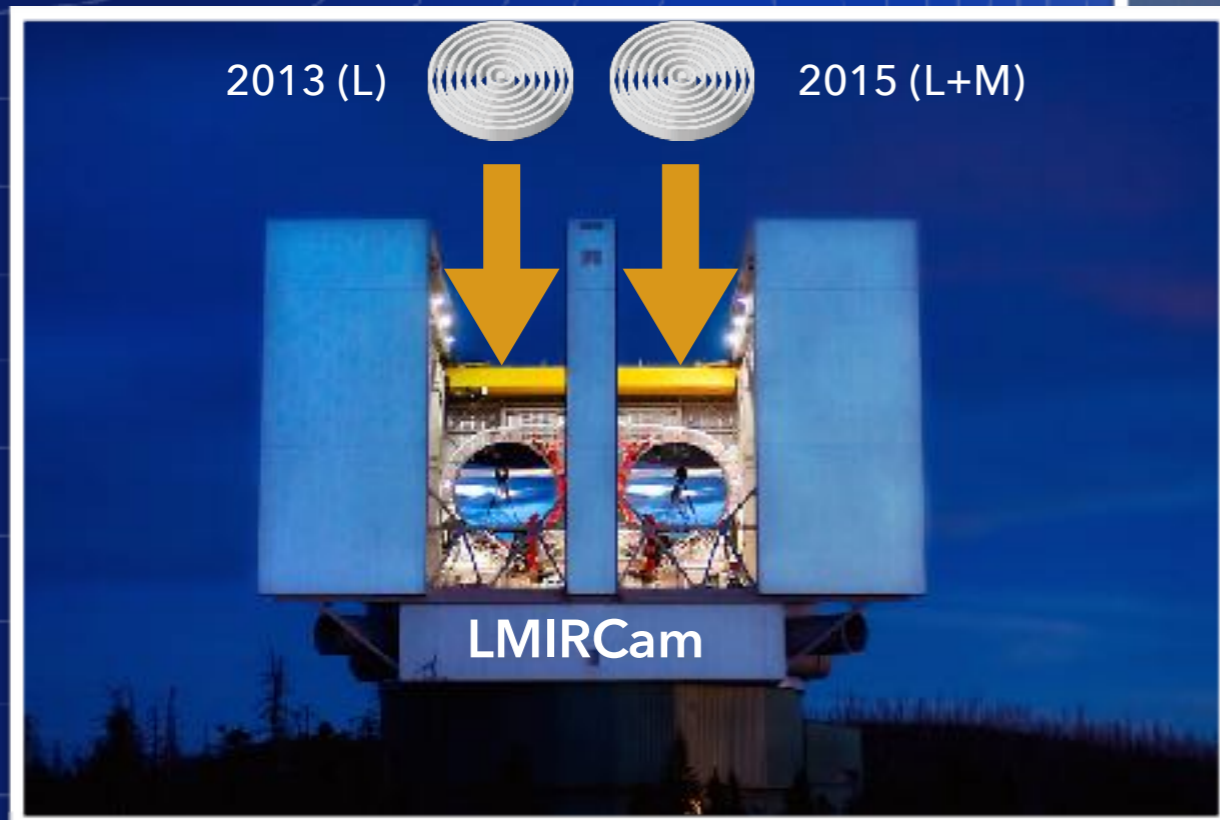

AGPM FIRST LIGHT @ NACO (DEC 2012)

- ▶ worked out of the box with available Lyot stops
- ▶ serendipitous discovery of M2V at $2\lambda/D$ from F0V

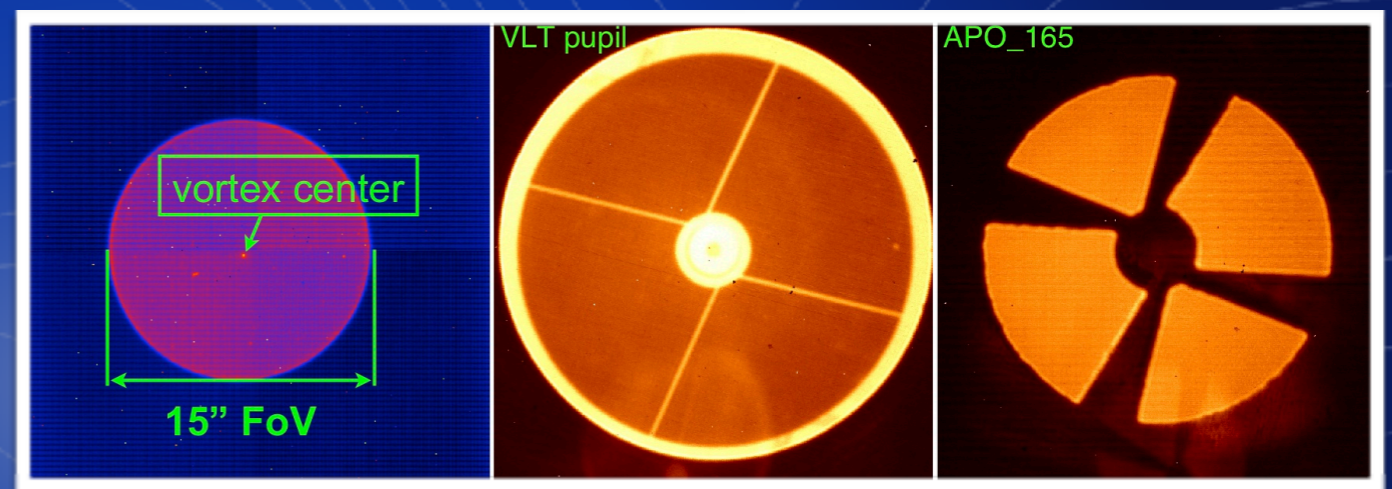

Mawet et al. (2013)

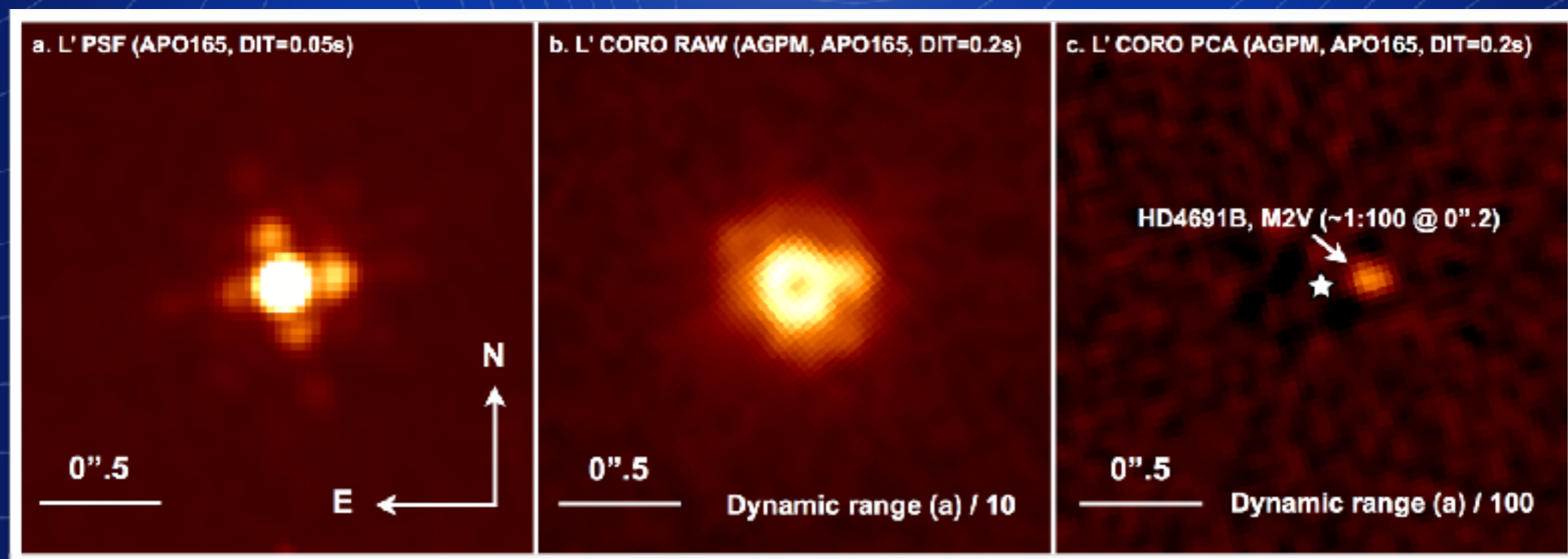

ON-SKY OPERATIONS: THE VORTEX GLOWS!

- ▶ thermal emission outside pupil partly diffracted inside pupil by vortex
- ▶ seen in all instruments (vortex upstream cold stop)
- ▶ removed by background subtraction
- ▶ useful for centering

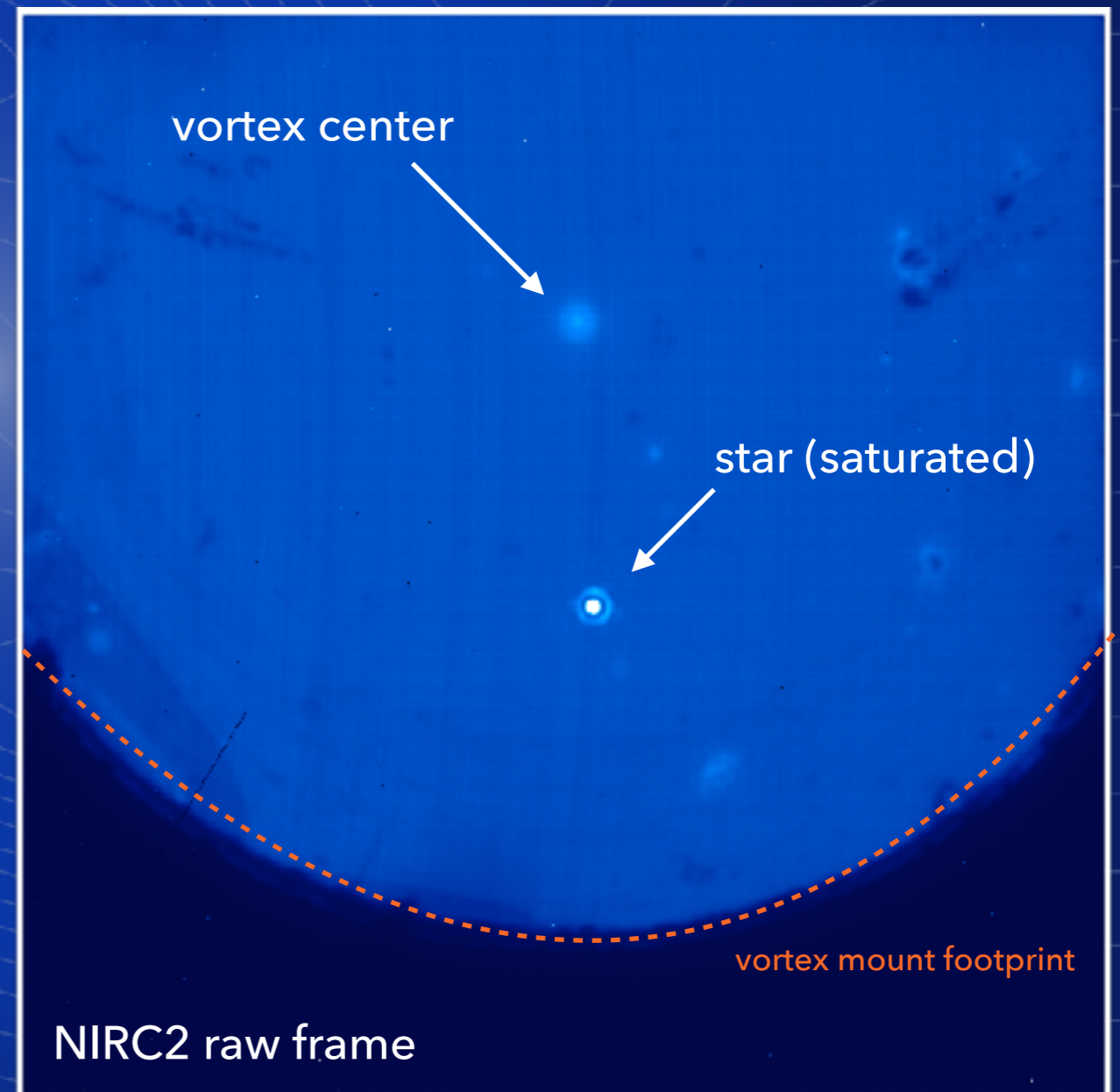

ON-SKY OPERATIONS: ACQUISITION & CENTERING

- ▶ pointing errors create asymmetric « donut »
- ▶ central obstruction changes the expected behavior of the donut
- ▶ need modeling to infer pointing error from image (QACITS algorithm)
- ▶ can be used to control pointing at low frequency

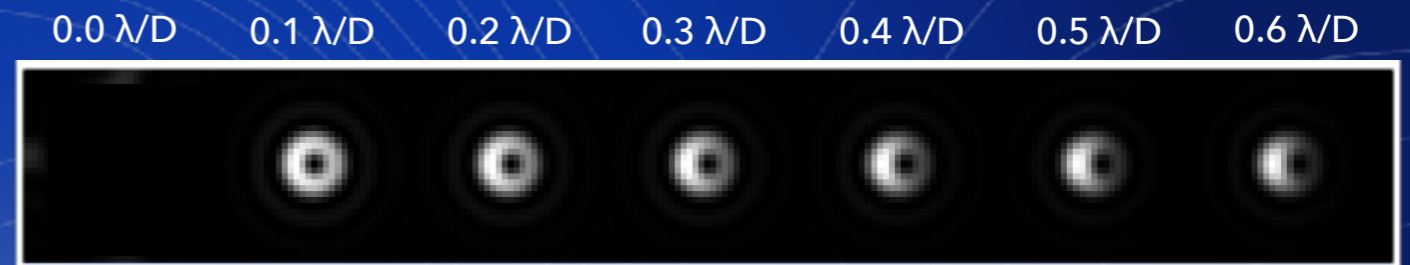

w/o central obstruction

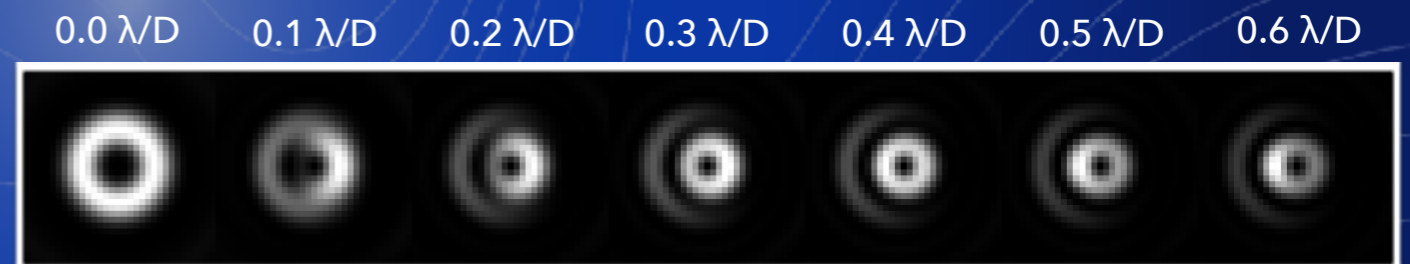

w/ central obstruction

CLOSED-LOOP CENTERING CONTROL

- ▶ fully automated vortex operations with QACITS validated on NIRC2
 - * includes acquisition & calibration
- ▶ ensures consistent centering and data quality
- ▶ rms jitter $\sim 0.02 \lambda/D$ (@ 0.03 Hz)

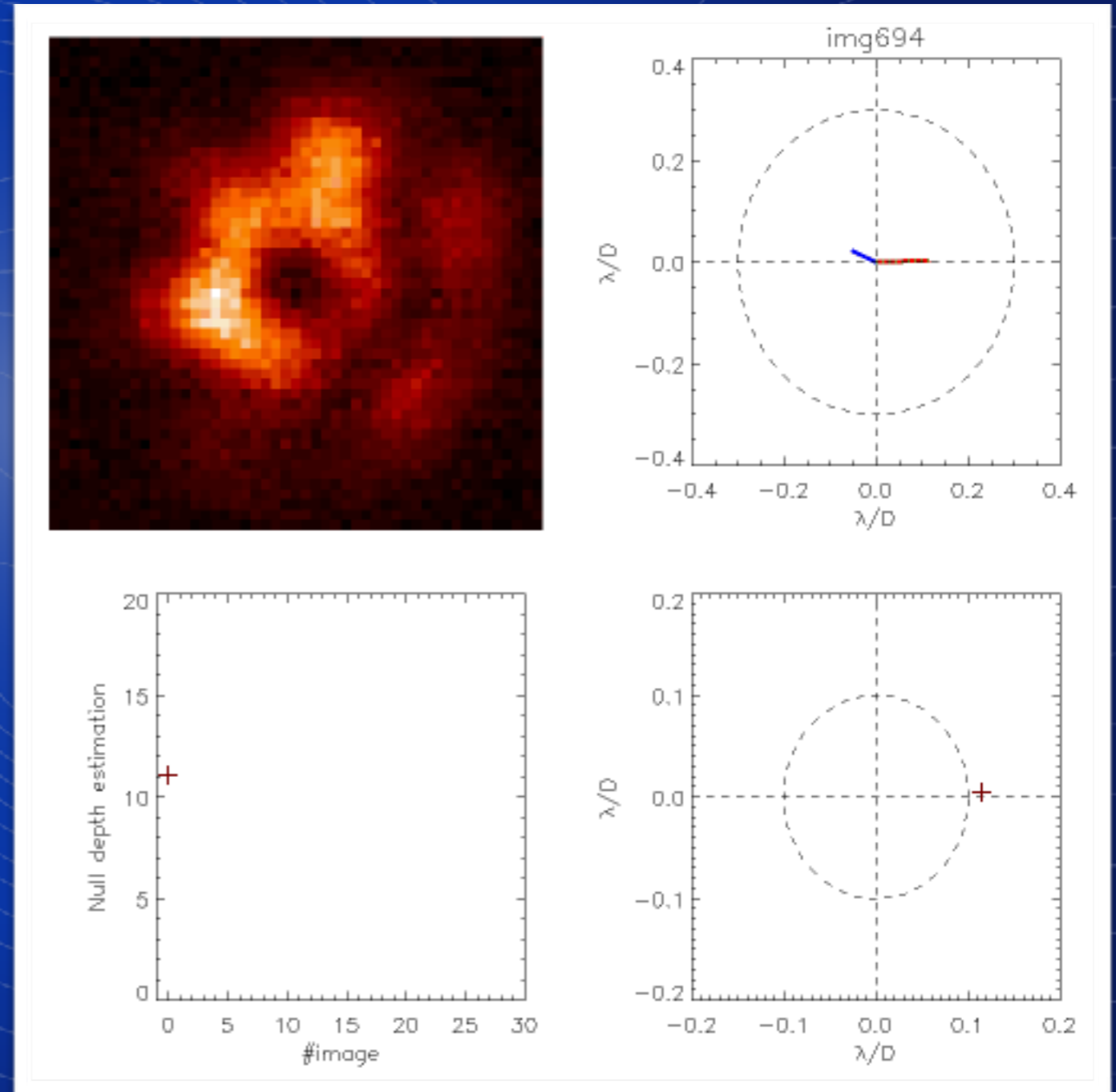

ON-SKY STARLIGHT CANCELLATION @ NIRC2

- ▶ on-sky extinction limited by
 - * pupil geometry / Lyot stop
 - * AO residuals
 - * non-common path aberrations

- ▶ daytime speckle nulling helps reduce NCPA ... but NIRC2 upgrade needed!

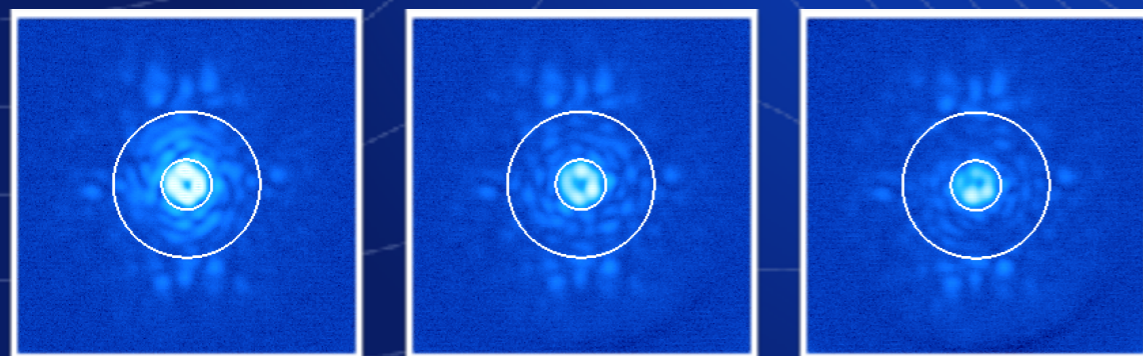
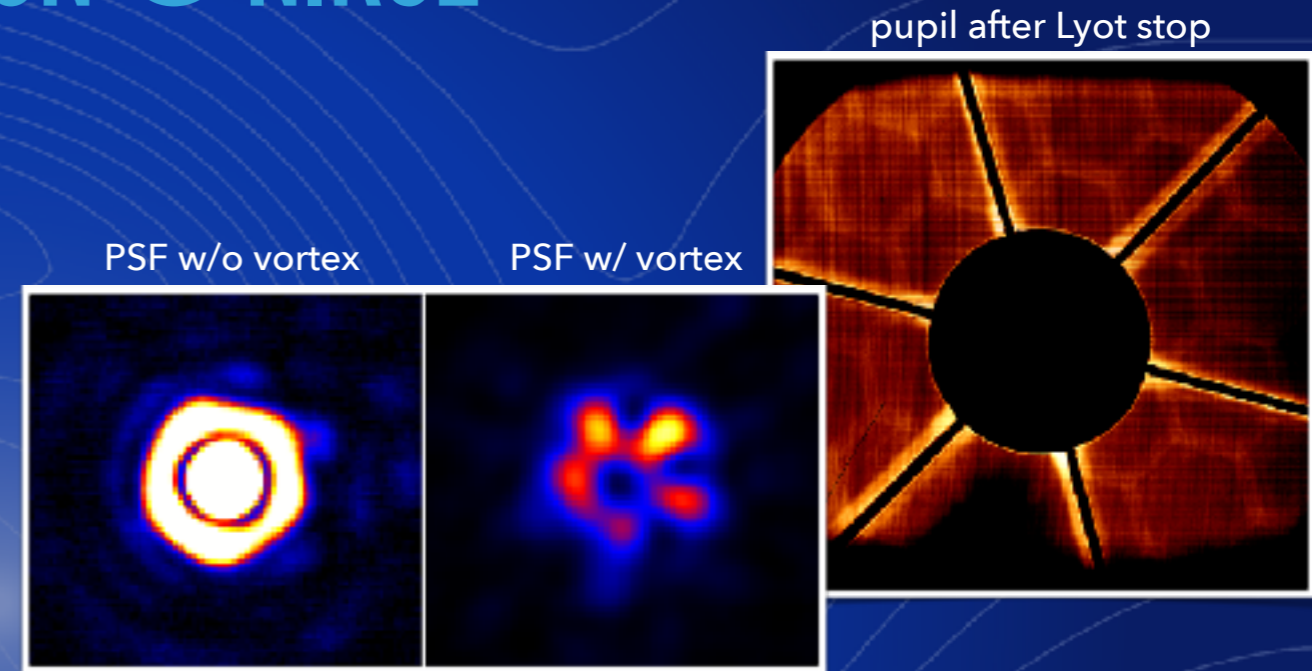

Bottom et al. (in prep)

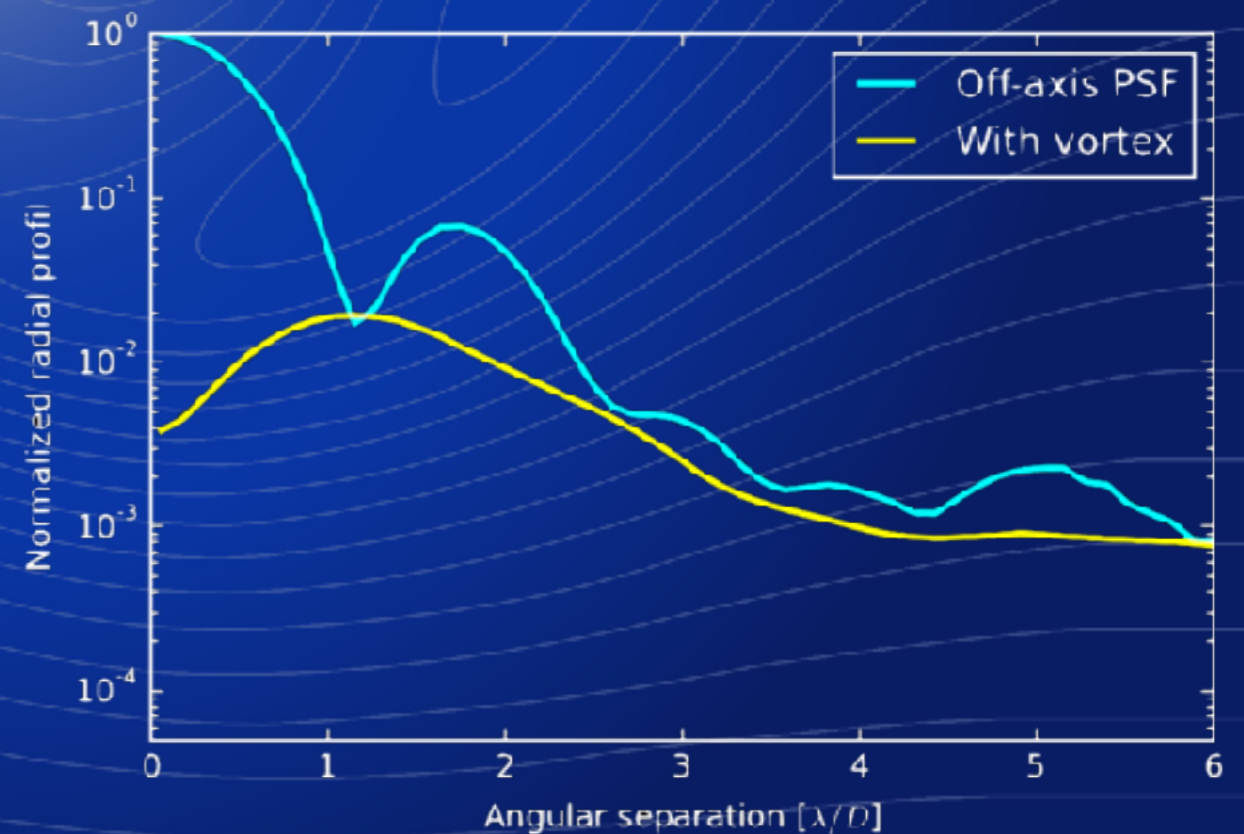

IMPROVEMENT IN DETECTION LIMITS @ NIRC2

- ▶ obvious gain in 3–10 λ/D region (0.25" – 0.8")
- ▶ vortex transmission detrimental @ 1-2 λ/D

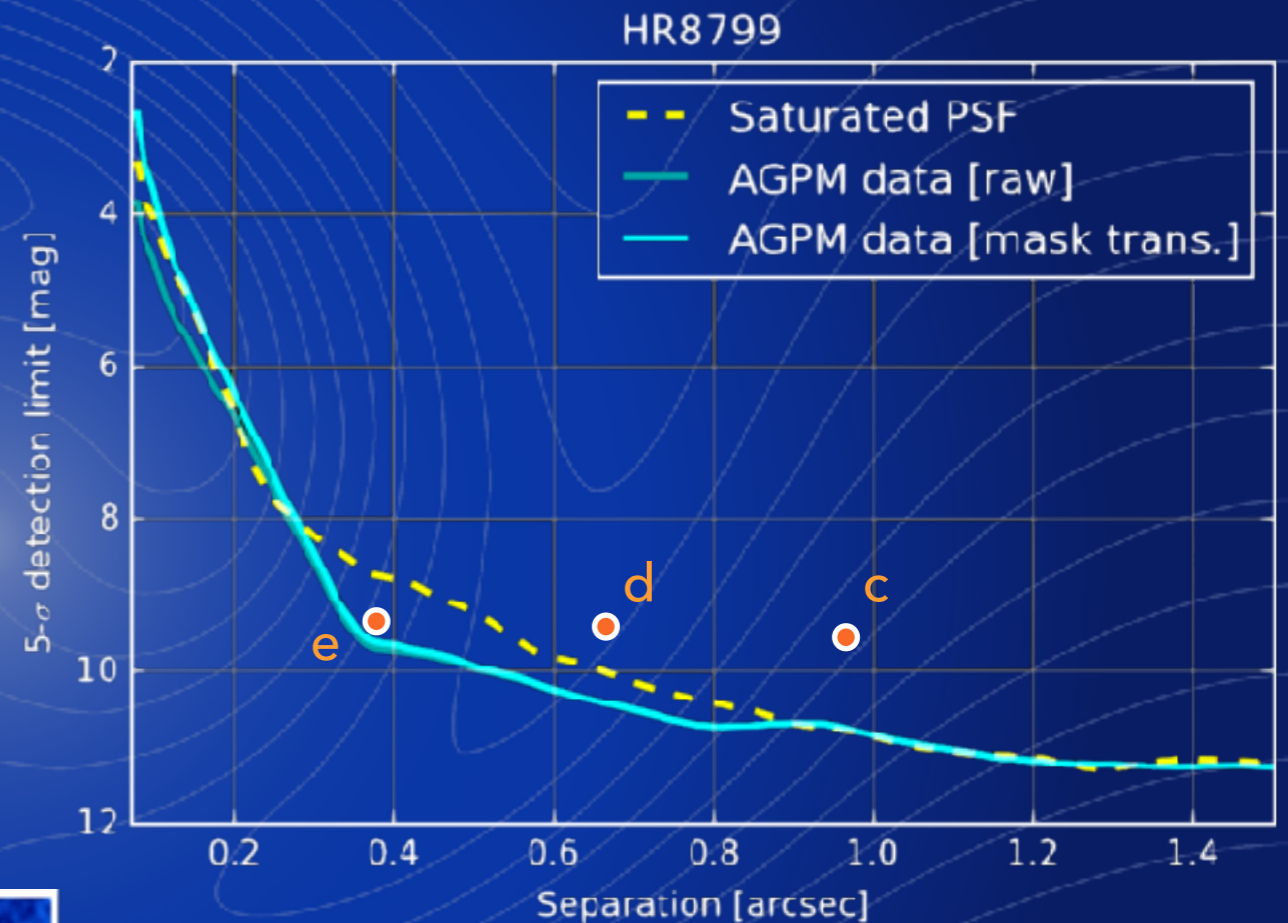

saturated imaging

vortex imaging

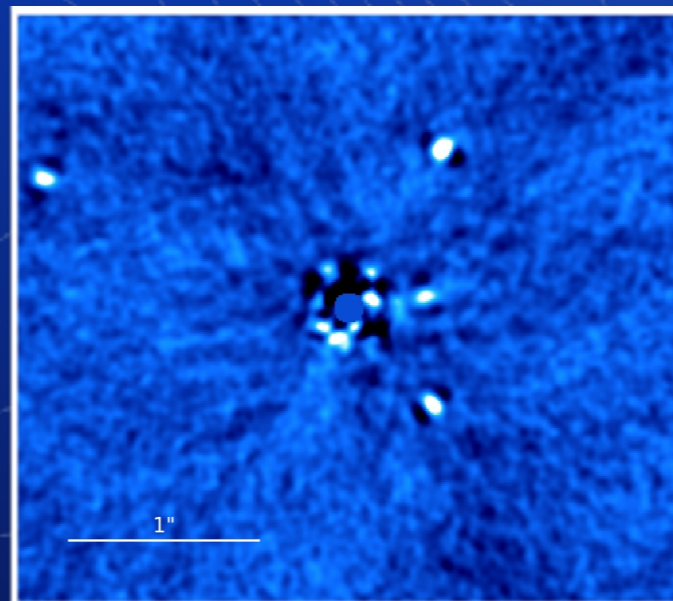
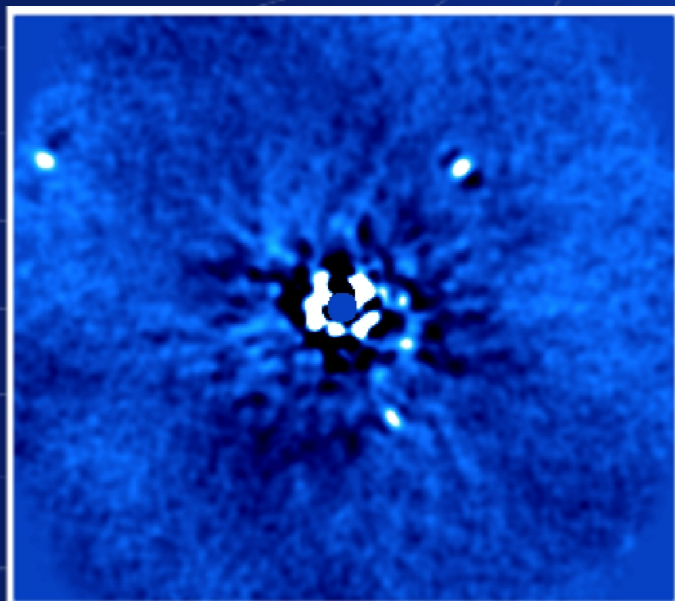

comparison based on two HR8799 data sets with similar integration time and parallactic angle rotation, processed using a standard PCA-ADI algorithm

VORTEX PERFORMANCE ON VARIOUS INSTRUMENTS

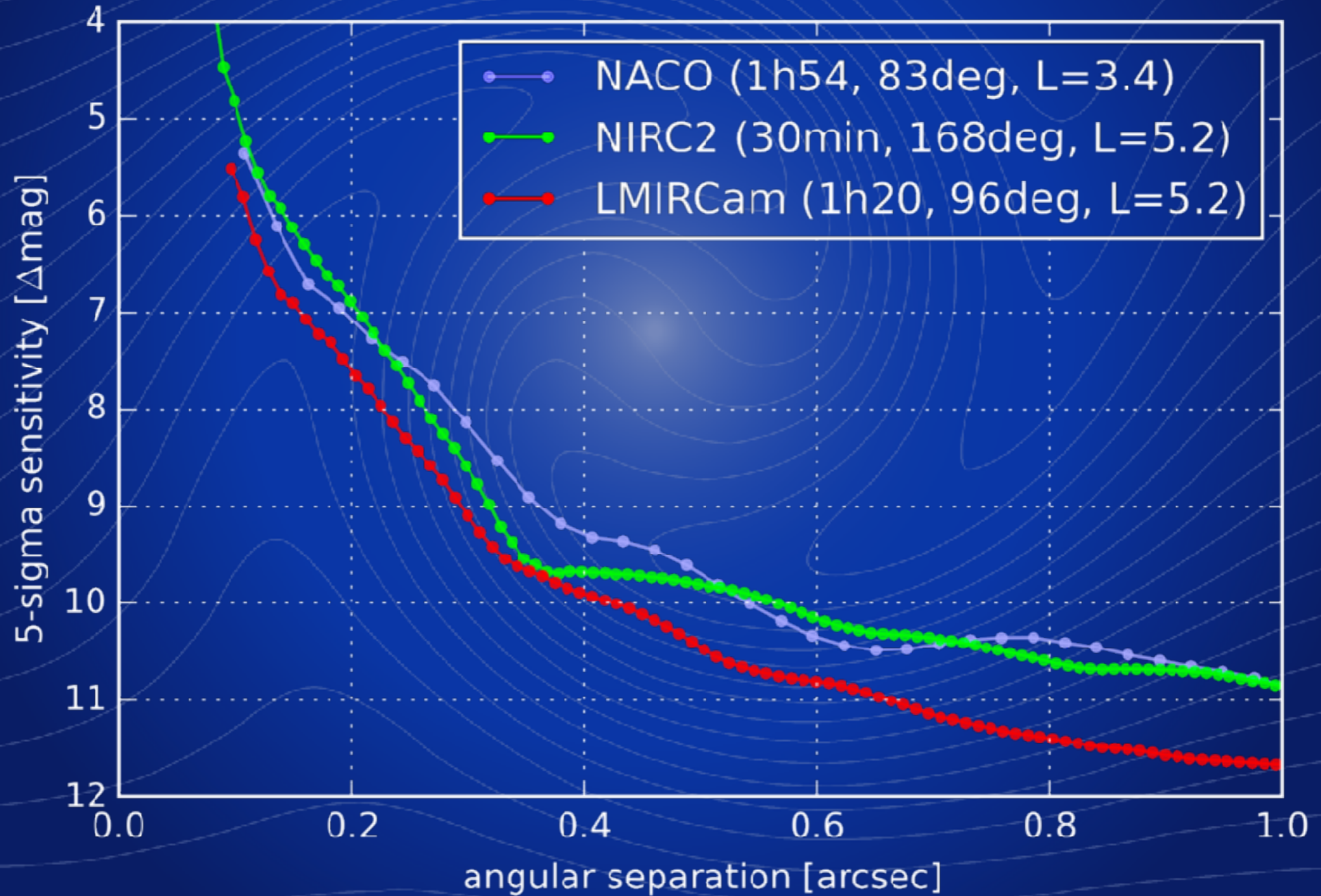



SCIENTIFIC RESULTS

EARLY SCIENCE @ VLT/NACO: HD 169142

Biller et al. 2014, Reggiani et al. 2014

- ▶ point-like source at 0.15" from Herbig Ae star, inside H-band PDI inner cavity
- ▶ not detected at J band (GPI) nor H-K bands (MagAO)
- ▶ possible explanations
 - * accreting protoplanet?
 - * disk feature?

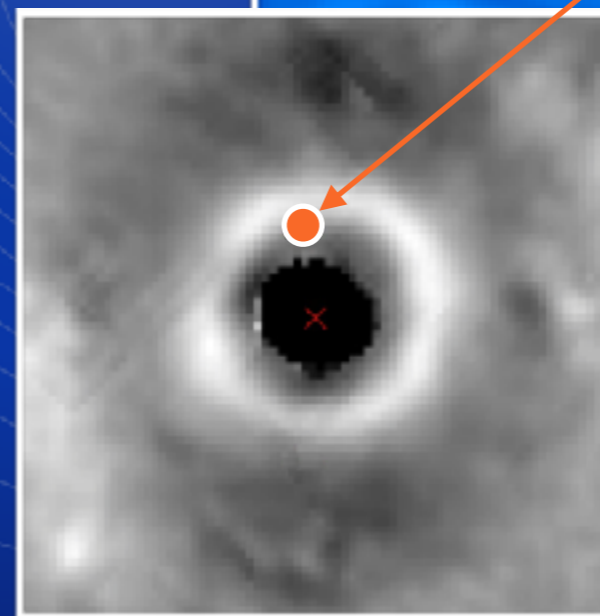
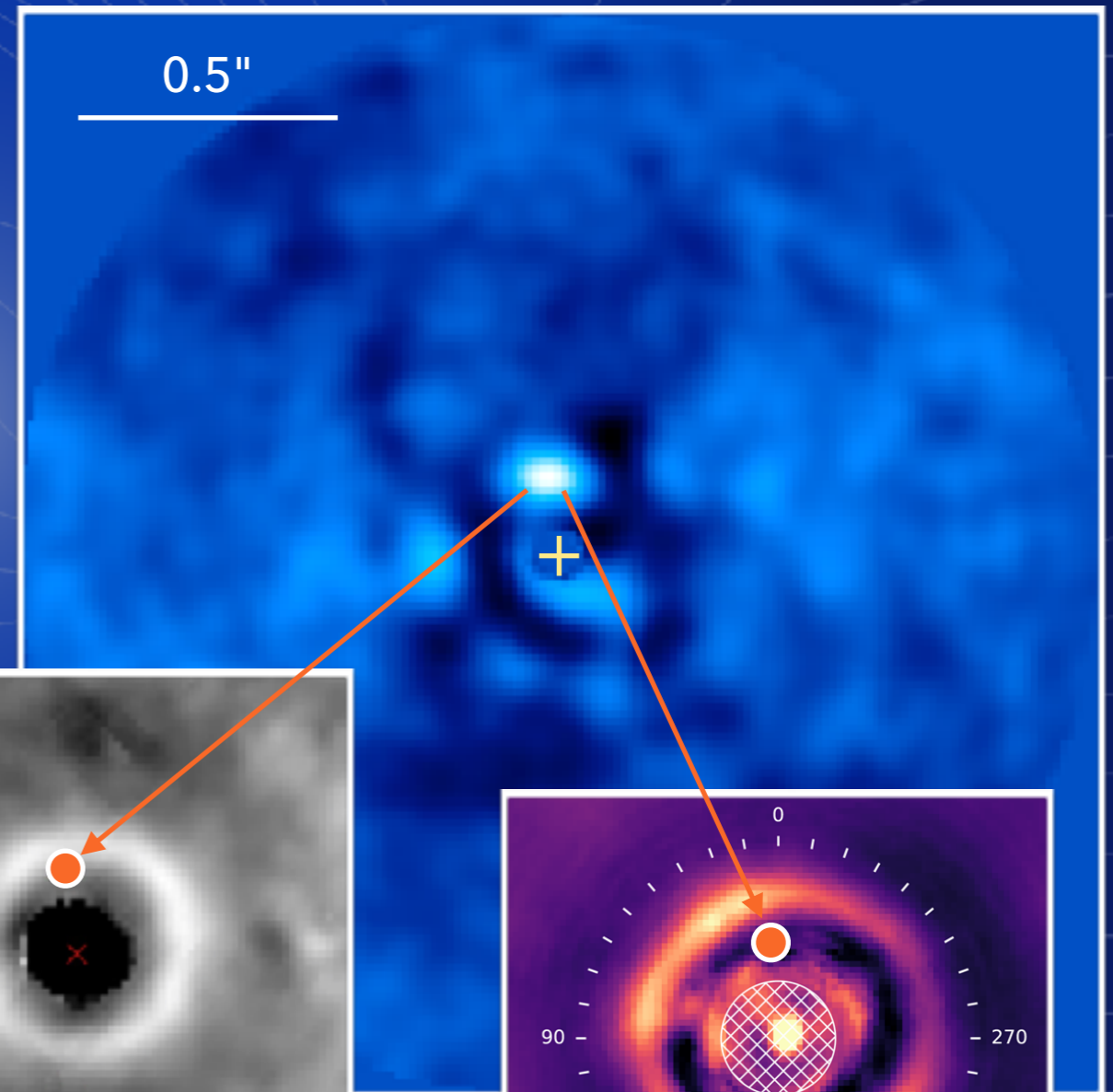

Quanz et al. 2013

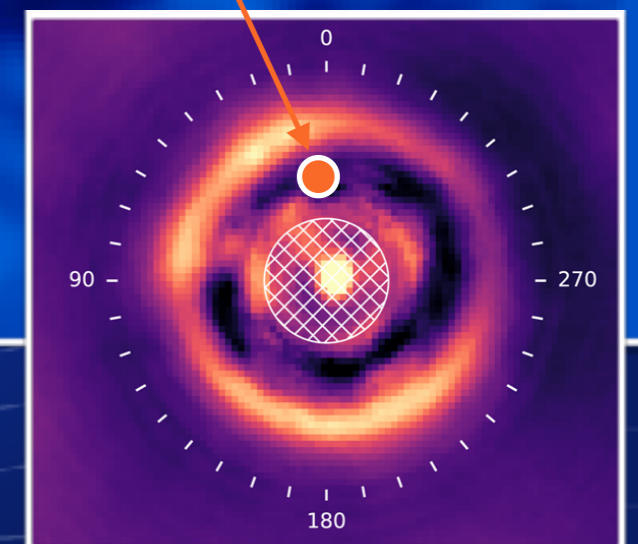

Ligi et al. 2018

FIRST LIGHT @ KECK/NIRC2: HIP 79124

Serabyn et al. (2017)

- ▶ brown dwarf around Sco-Cen A0 star
- ▶ 177 mas, $\Delta L=4.3$
- ▶ only detected with aperture masking so far
- ▶ recovered with NIRC2+vortex during commissioning

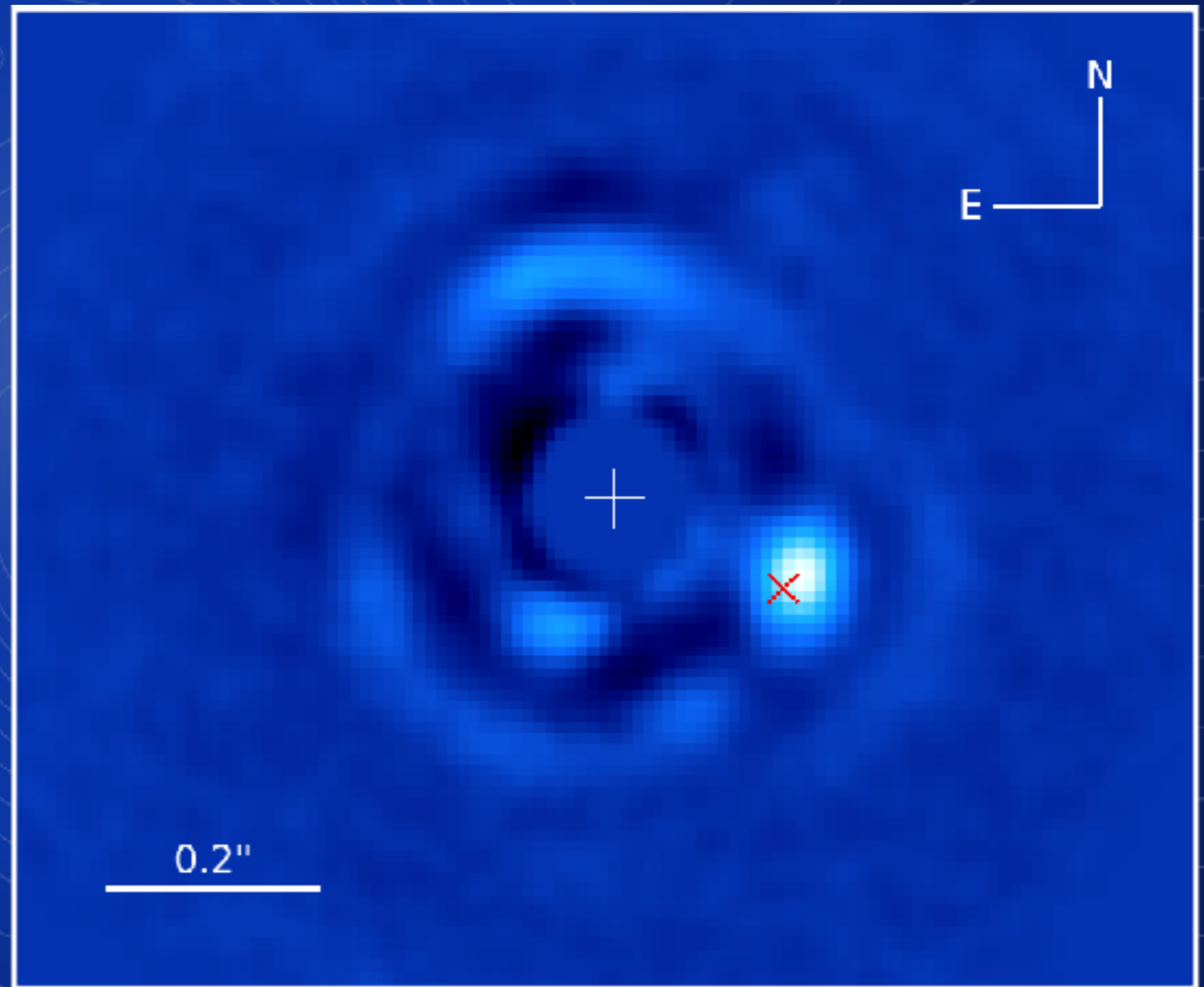

KECK CORONAGRAPHIC DEEP FIELD: TW HYA

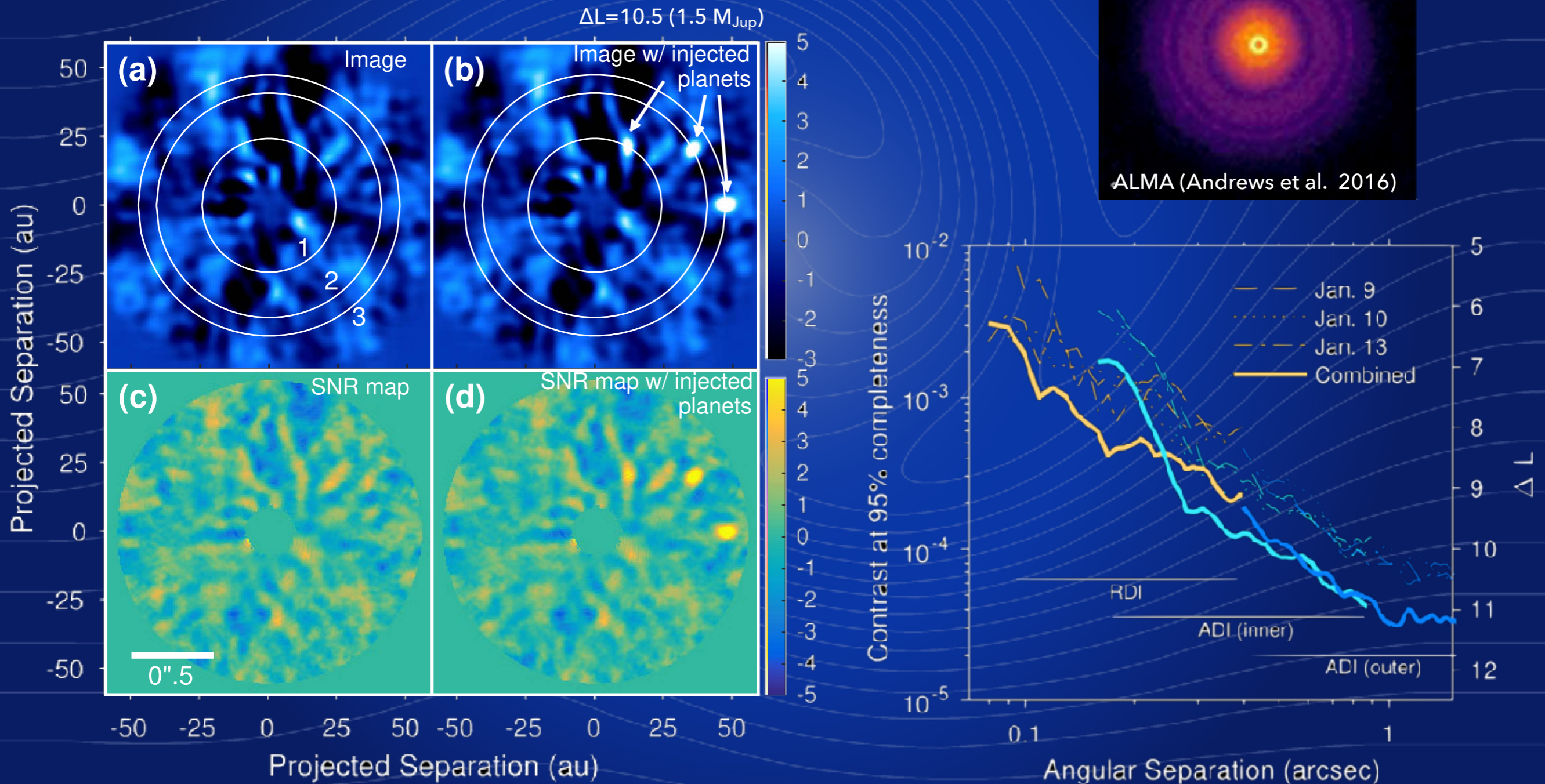

CONSTRAINING (PROTO)PLANETS IN TW HYA DISK

- ▶ protoplanet with circumplanetary disk truncated at $\sim 1 R_{Jup}$ presently accreting at a rate insufficient to form a Jupiter-mass planet

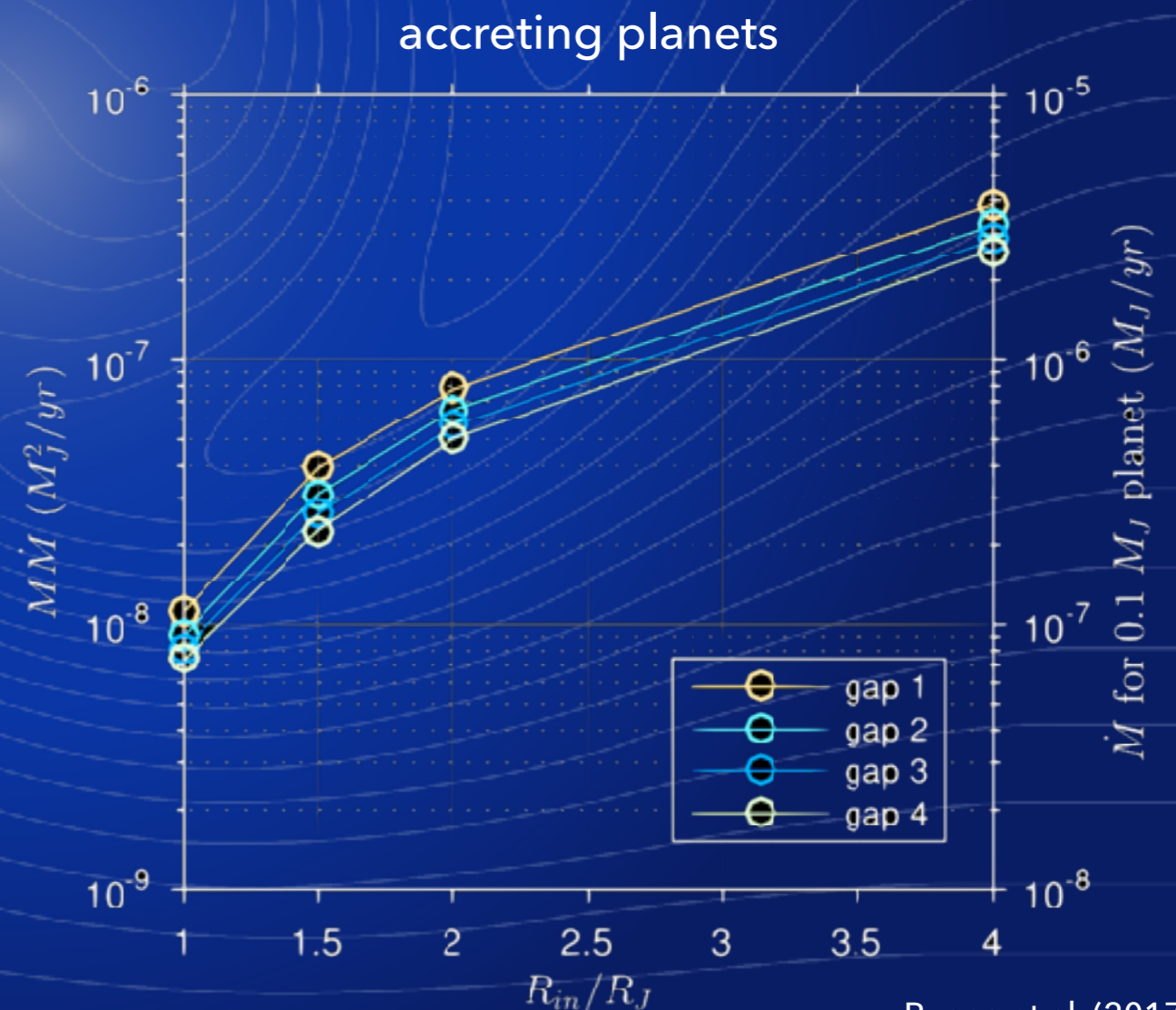
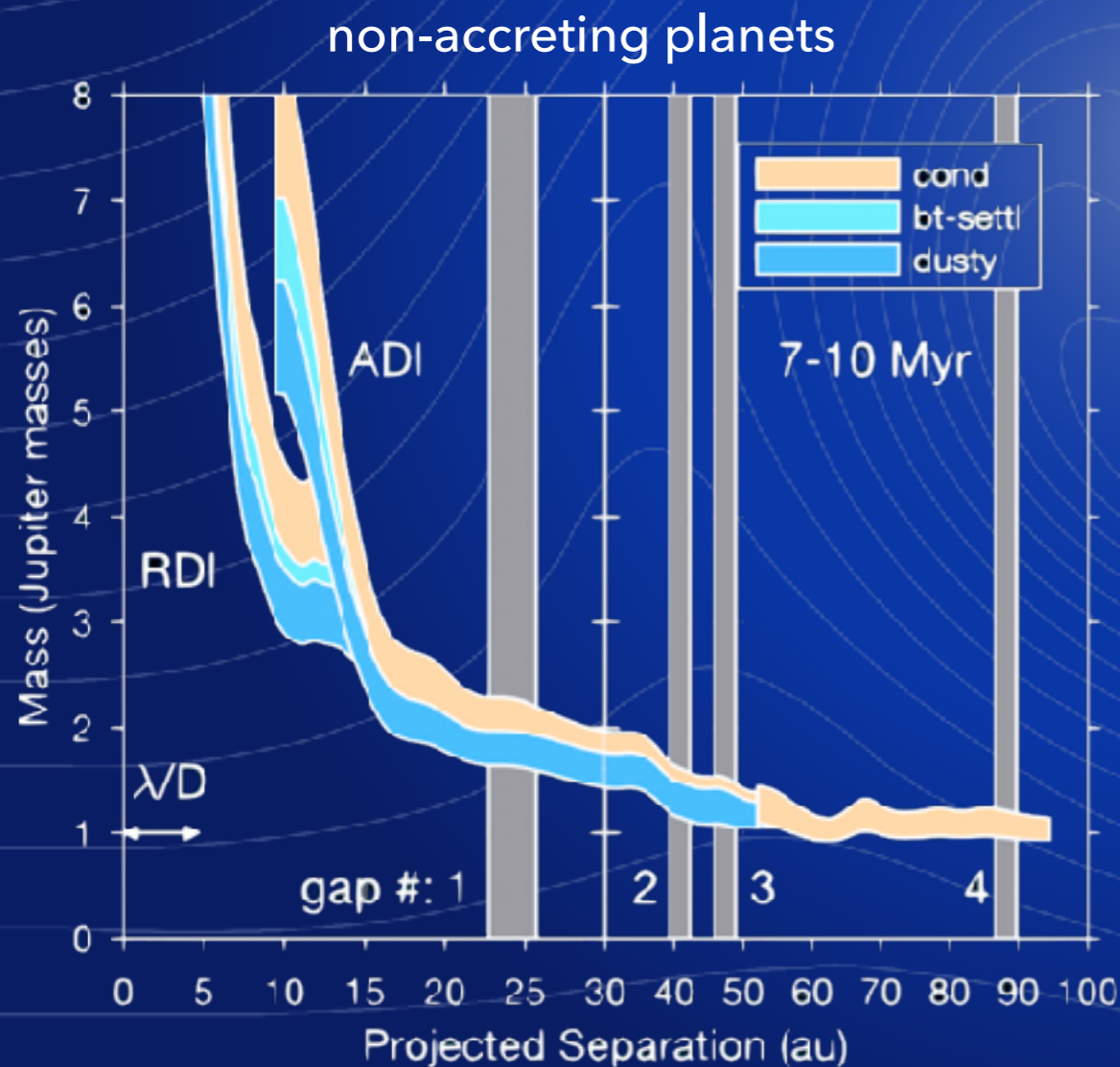

TRANSITION DISK SURVEY (NIRC2 & NACO)

SPHERE/IRDIS Y band polarimetry (Benisty et al. 2015)

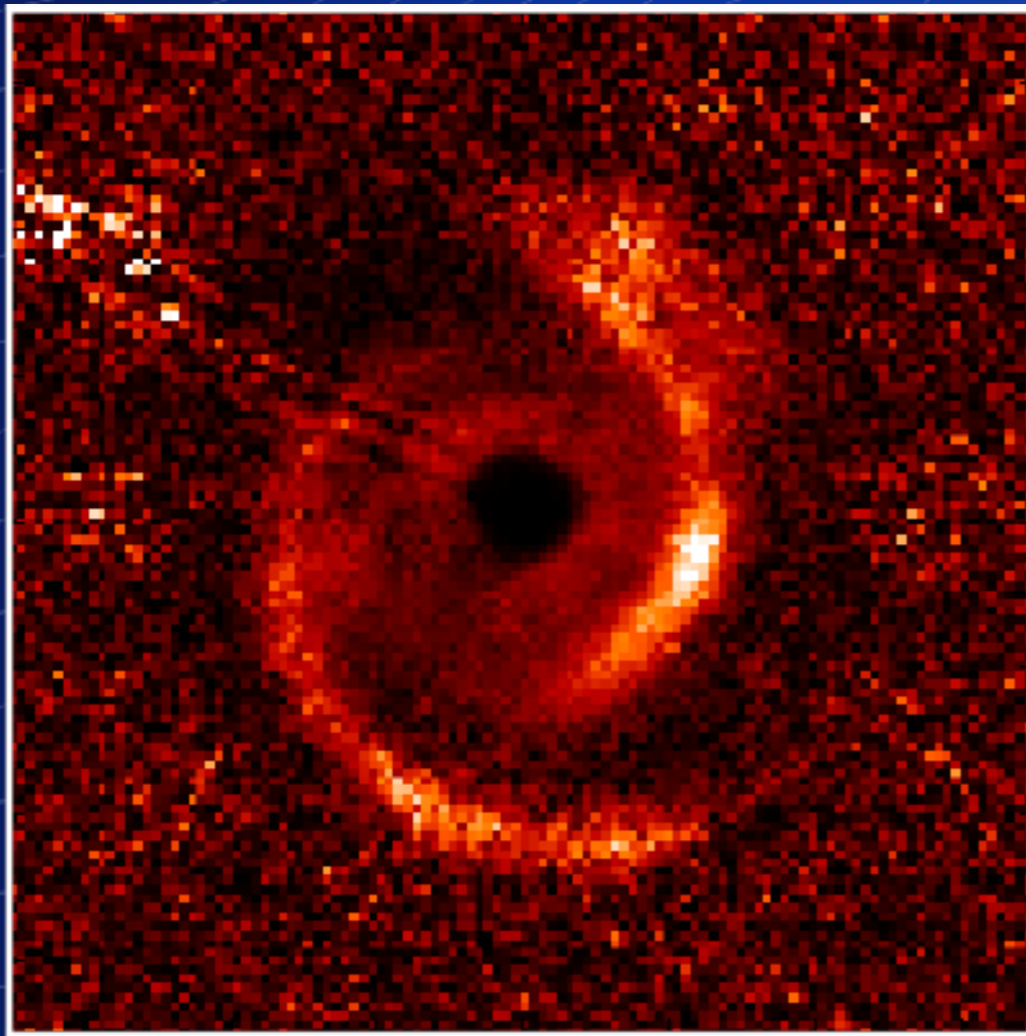

Protoplanet prediction (Dong et al. 2015)

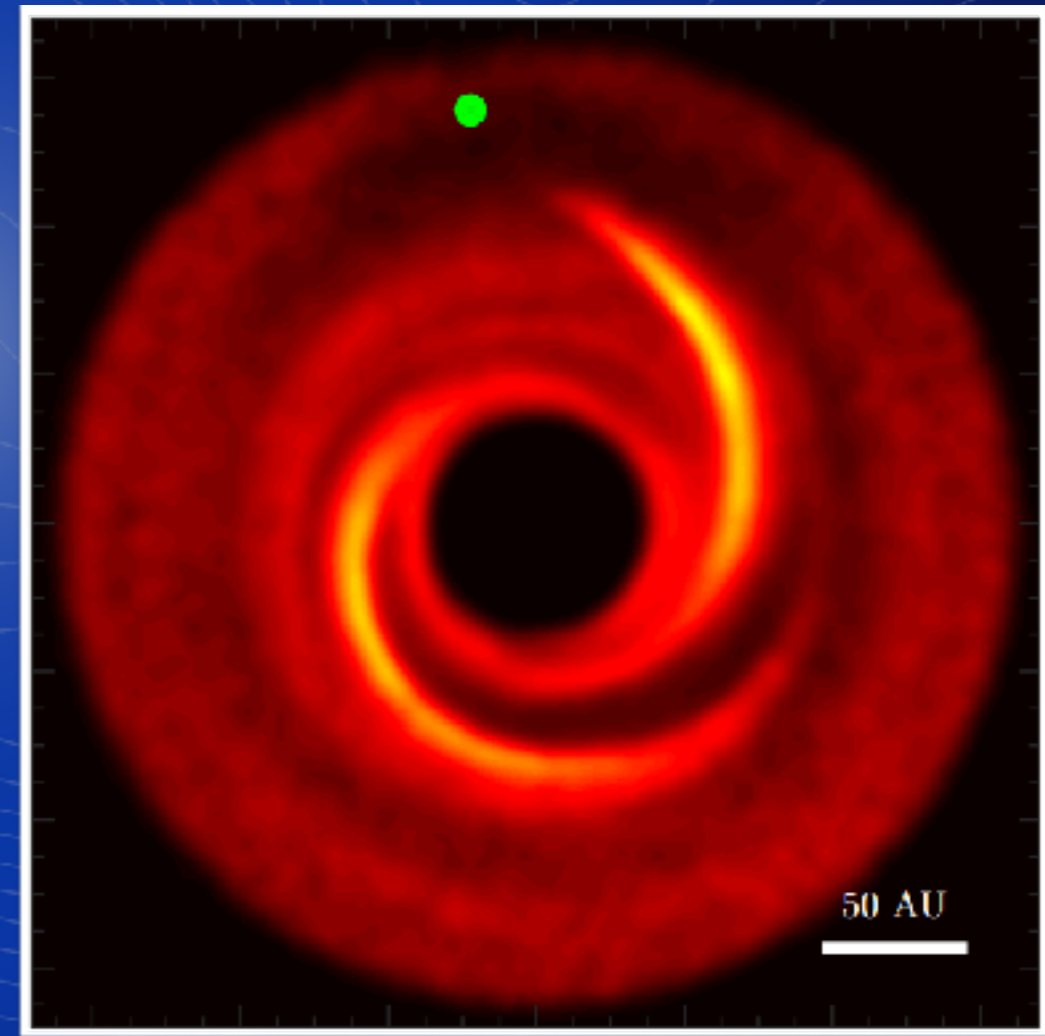

goal: search for protoplanets at the origin of disk structures

THE KECK/NIRC2 + VORTEX VIEW OF MWC758

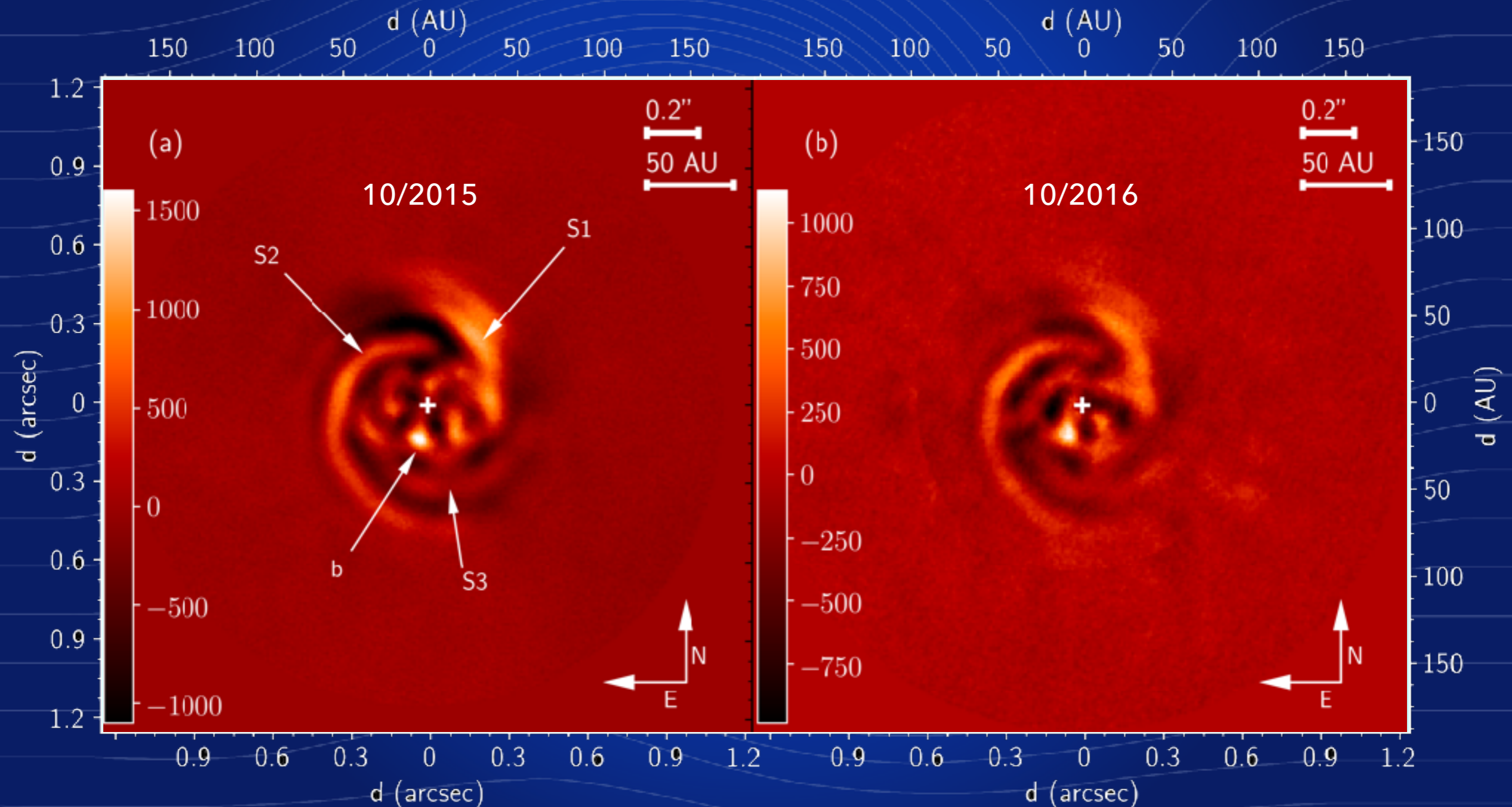

MWC758: YET ANOTHER PROTOPLANET CANDIDATE?

▶ main properties

- * 0.1'' separation (20 au), $\Delta L = 7$
- * two epochs: PA difference consistent with Keplerian rotation in 1 yr

▶ low probability for bckg star

- ▶ companion? needs to be $< 6 M_{\text{Jup}}$
→ not purely photospheric emission

▶ conclusion: accreting protoplanet or disk feature?

- * no polarized disk emission there!

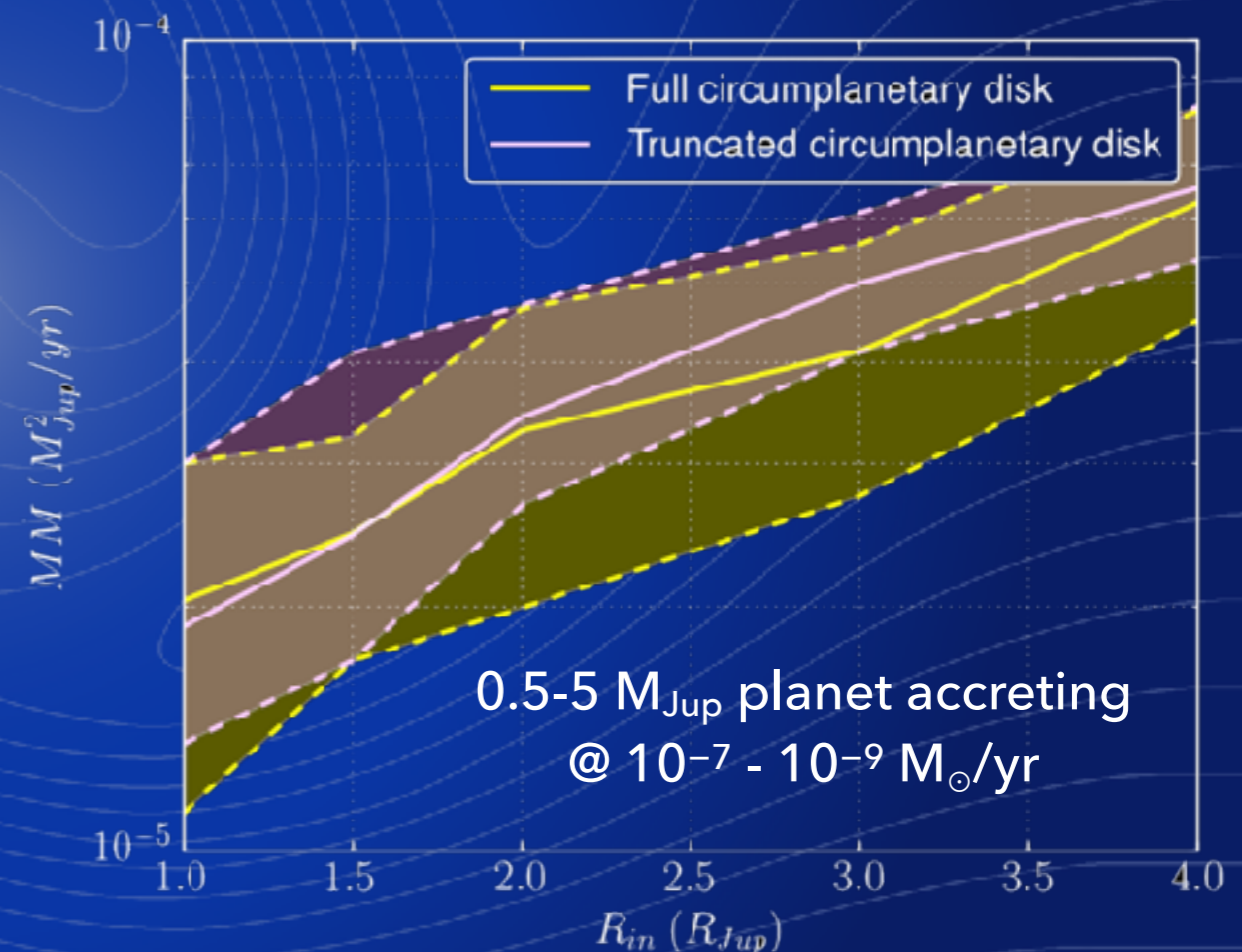

MWC758: ORIGIN OF THE SPIRALS?

- ▶ now three spiral arms to reproduce with models
- ▶ driven by protoplanet?
 - * outer planet? most likely explanation based on models, but strong constraints from observations ($< 6 M_{\text{Jup}}$)
 - * inner planet? might explain one spiral, but not all three

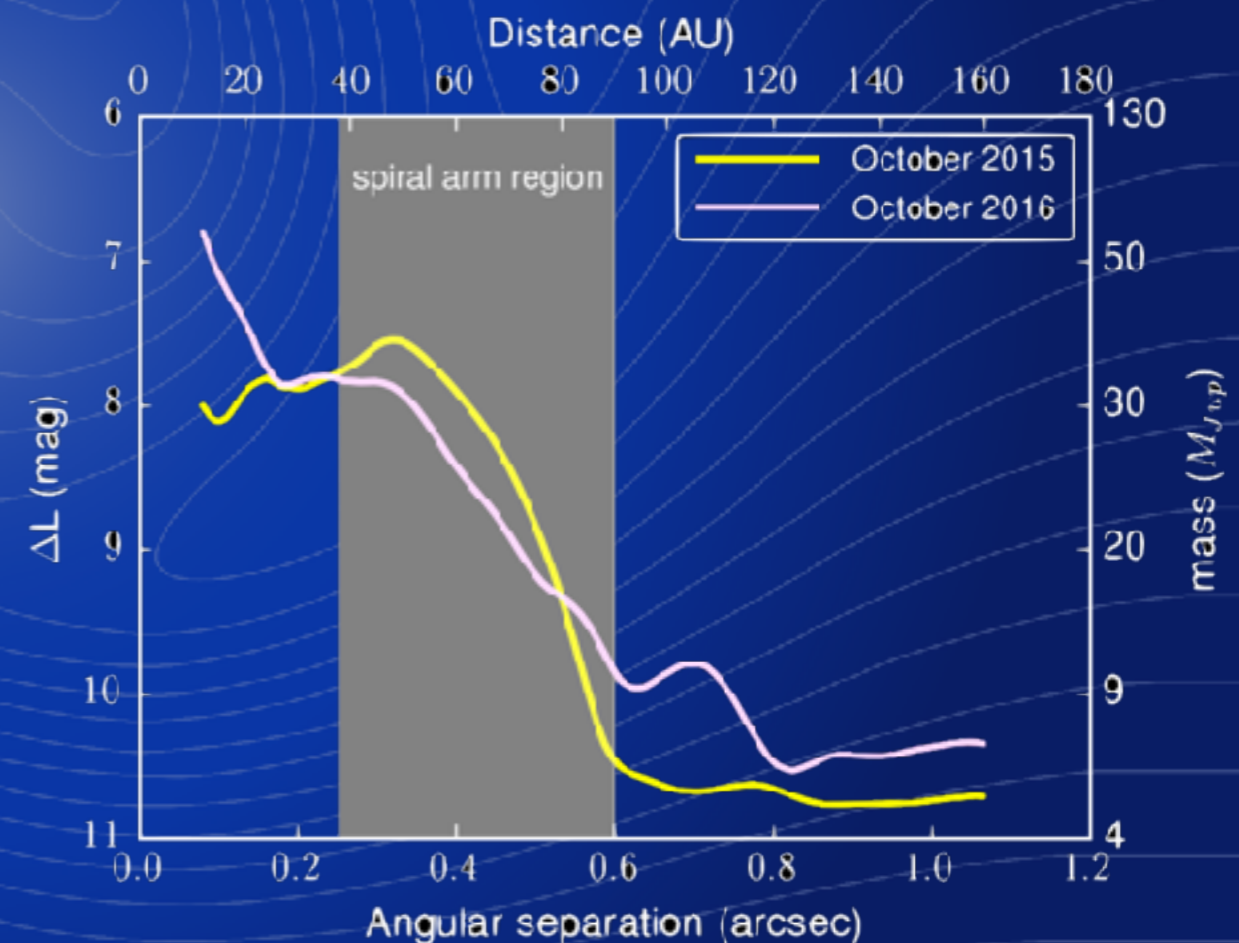

HOW TO BETTER EXPLOIT THE DATA?

▶ interesting science at $1-3 \lambda/D$

- * strongly affected by residual speckles
- * non-Gaussian noise
→ more false positives
- * hard to validate candidates

NIRC2+vortex image sequence

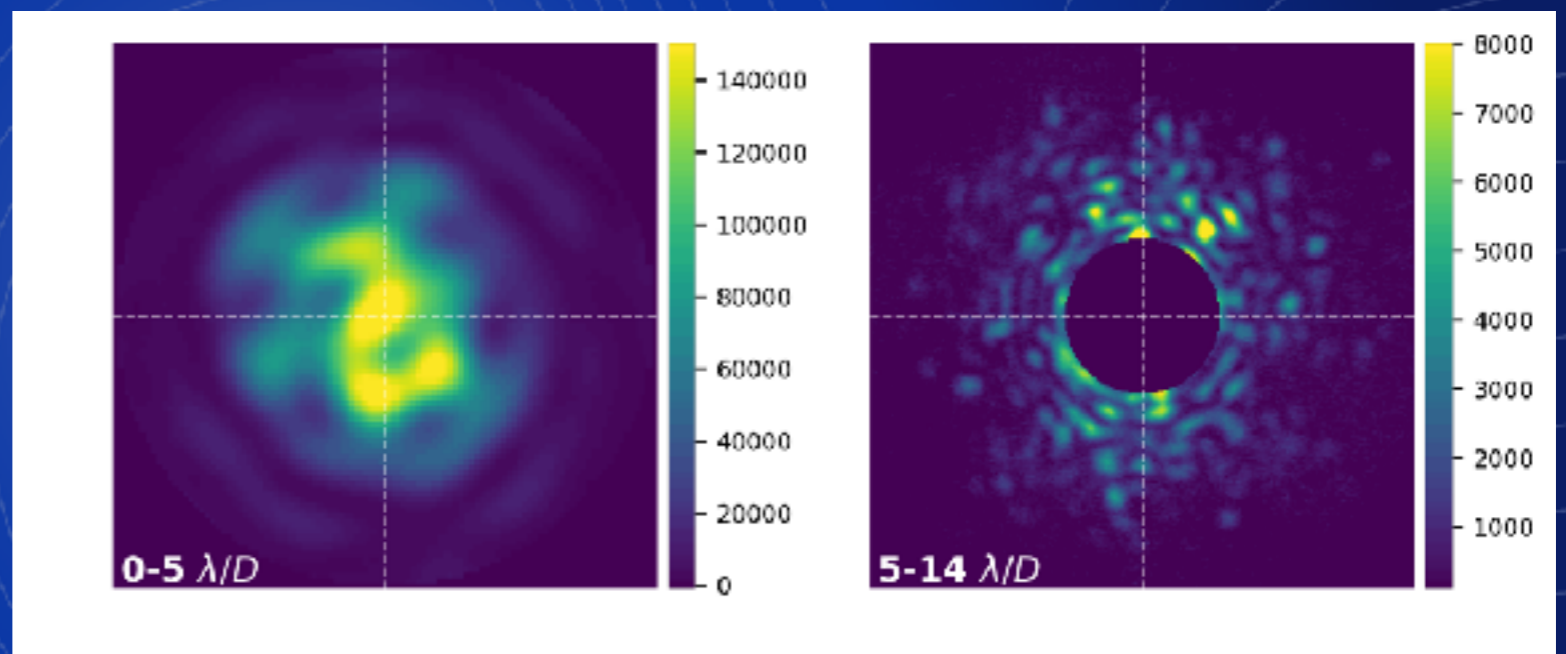

- ▶ ADI-based techniques produce SNR, but do not inform on nature of the source
- ▶ machine learning can help

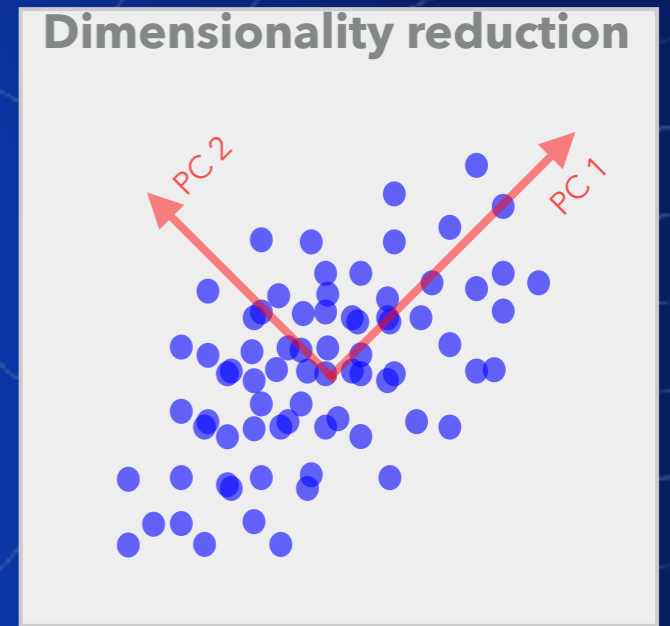
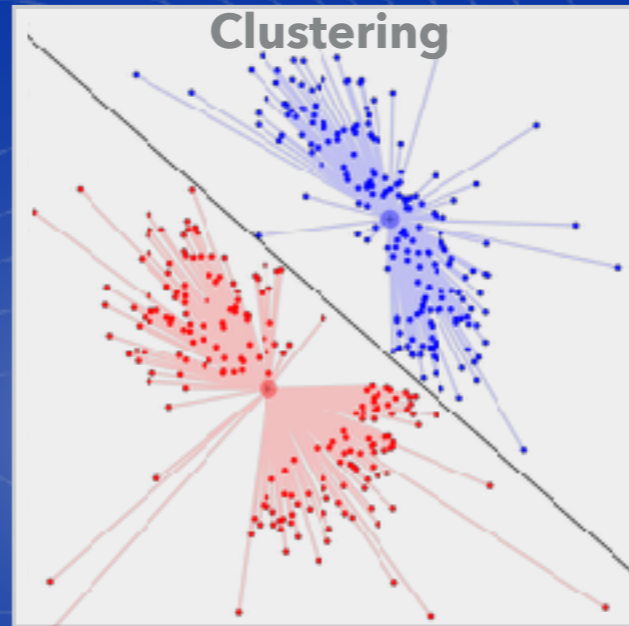

**IMAGE PROCESSING
WITH
MACHINE LEARNING**

MACHINE LEARNING IN A NUTSHELL

- ▶ construction of algorithms that can learn from, and make predictions on data

Unsupervised



Supervised

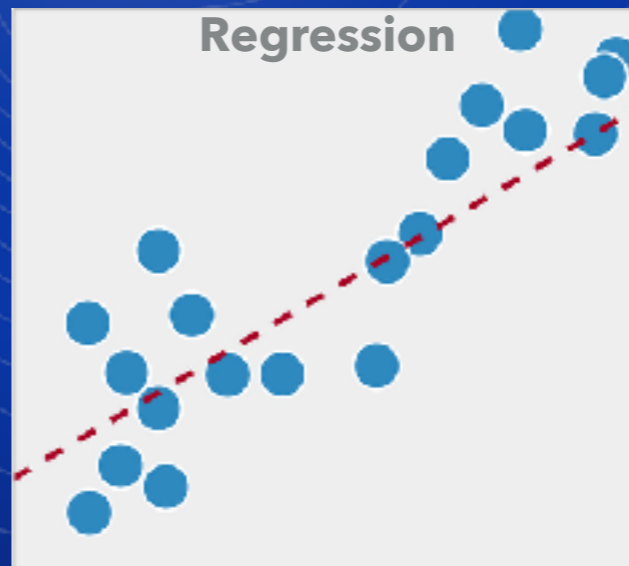

SUPERVISED LEARNING

- ▶ goal: learn function f mapping input samples \mathcal{X} to labels \mathcal{Y} given a labeled dataset $(x_i, y_i)_{i=1, \dots, n}$:

$$\min_{f \in \mathcal{F}} \frac{1}{n} \sum_{i=1}^n \mathcal{L}(y_i, f(x_i)) + \lambda \Omega(f)$$

- ▶ mapping function f based on (deep) neural network
 - * layers of neurons whose parameters can be tuned to approximate a complex function
 - * DNN can be trained with labeled datasets
- ▶ problem: need labels & large training sample!

SUPERVISED DETECTION OF EXOPLANETS

Gomez Gonzalez et al. (submitted)

1. generation of labeled data

2. training the DNN

3. prediction

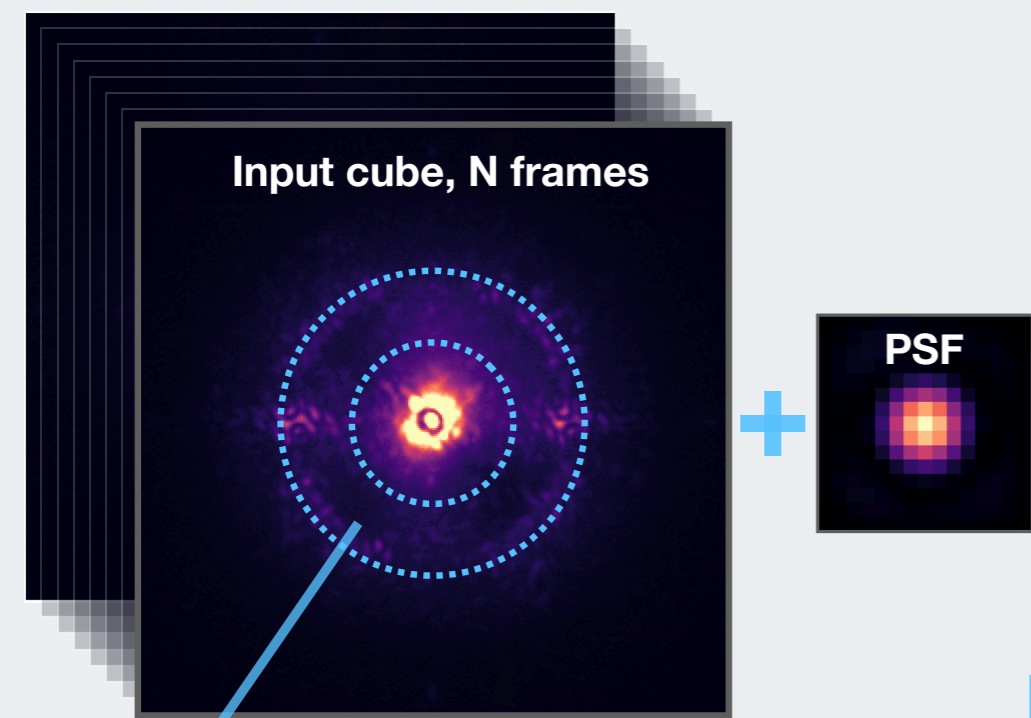

X and y to train/test/validation sets

Convolutional LSTM layer
kernel=(3x3), filters=40

3d Max pooling
size=(2x2x2)

Convolutional LSTM layer
kernel=(2x2), filters=80

3d Max pooling
size=(2x2x2)

Dense layer
units=128

ReLU activation + dropout

Output dense layer
units=1

Sigmoid activation

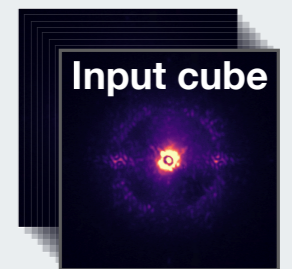

MLAR patches

Trained classifier

Probability of positive class

Binary map

probability threshold = 0.9

LABELED DATASET

Labels: $y \in \{c^-, c^+\}$

C⁻

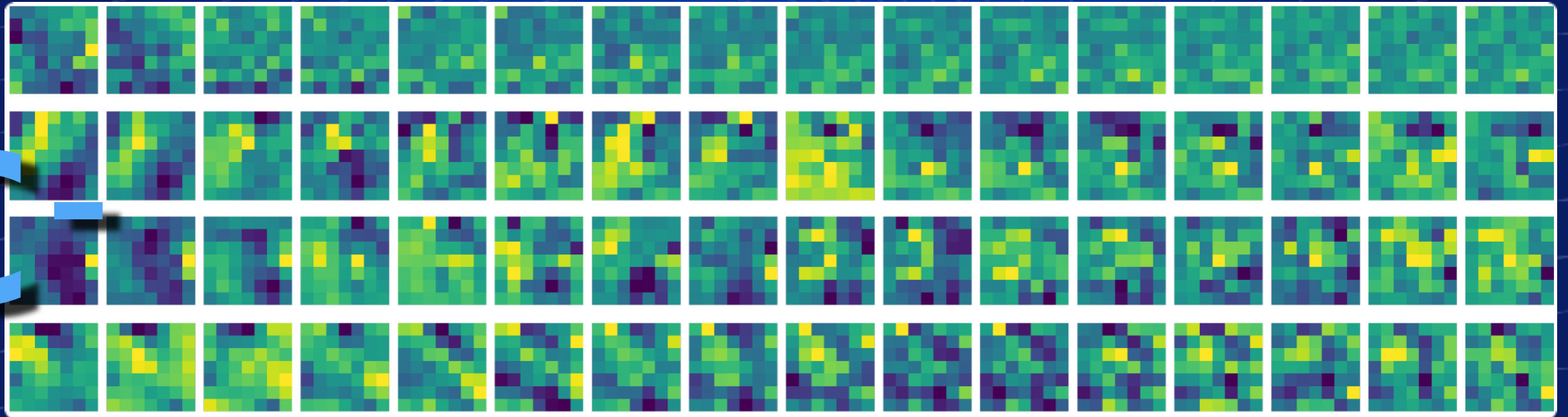

C⁺

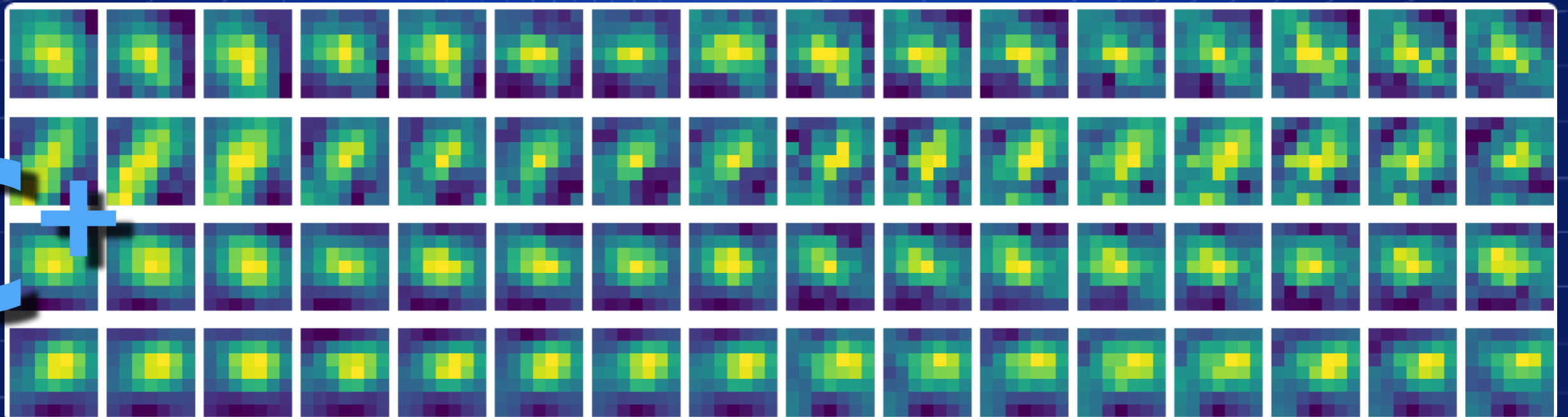

SUPERVISED DETECTION OF EXOPLANETS

Gomez Gonzalez et al. (submitted)

1. generation of labeled data

2. training the DNN

3. prediction

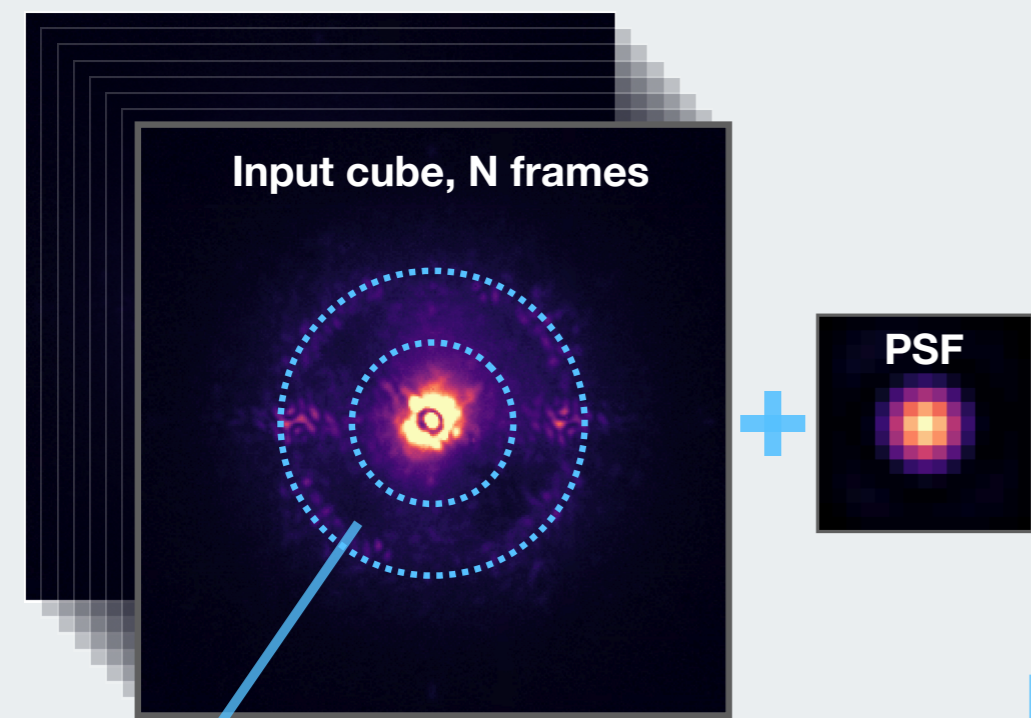

X and y to train/test/validation sets

Convolutional LSTM layer
kernel=(3x3), filters=40

3d Max pooling
size=(2x2x2)

Convolutional LSTM layer
kernel=(2x2), filters=80

3d Max pooling
size=(2x2x2)

Dense layer
units=128

ReLU activation + dropout

Output dense layer
units=1

Sigmoid activation

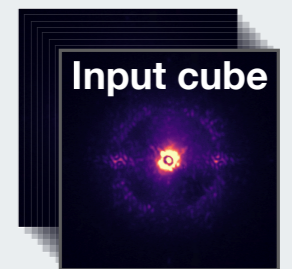

MLAR patches

Trained classifier

Probability of positive class

Binary map

probability threshold = 0.9

TEST WITH INJECTED COMPANIONS (SPHERE/IRDIS)

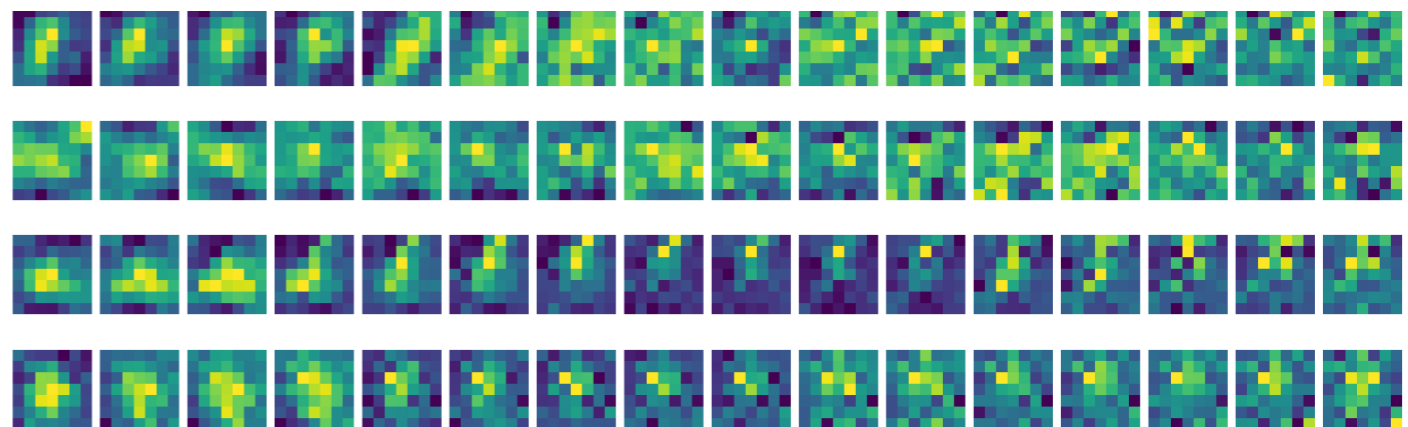
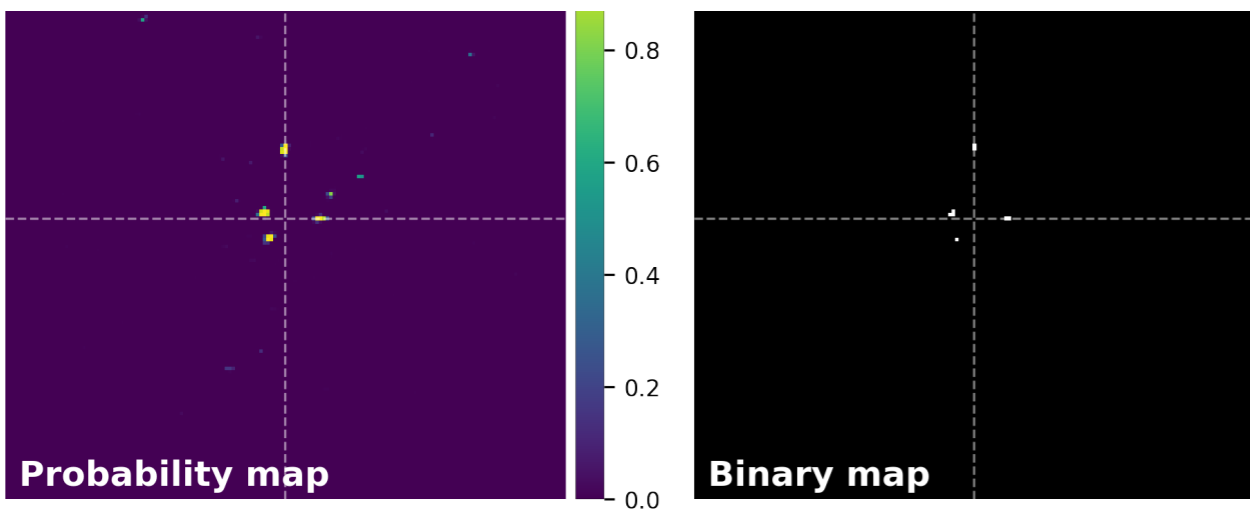
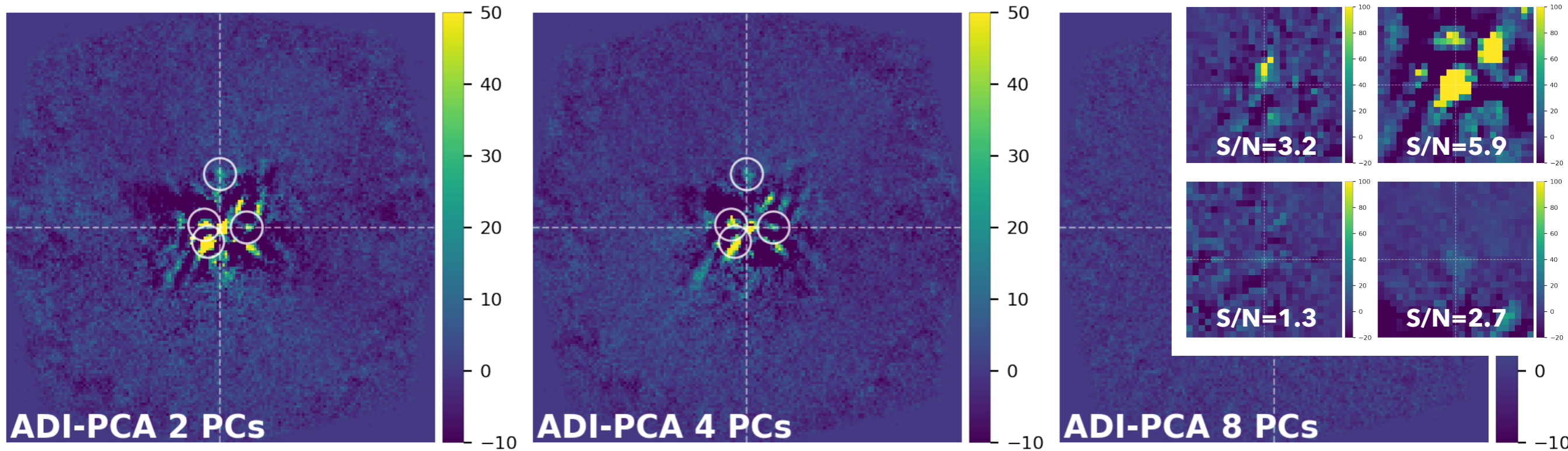

MLAR patches of 4 fake companions

ROC CURVES

► Separation

* $2 - 3 \lambda/D$

► Contrasts

* 2.9×10^{-5}
to 1.4×10^{-4}

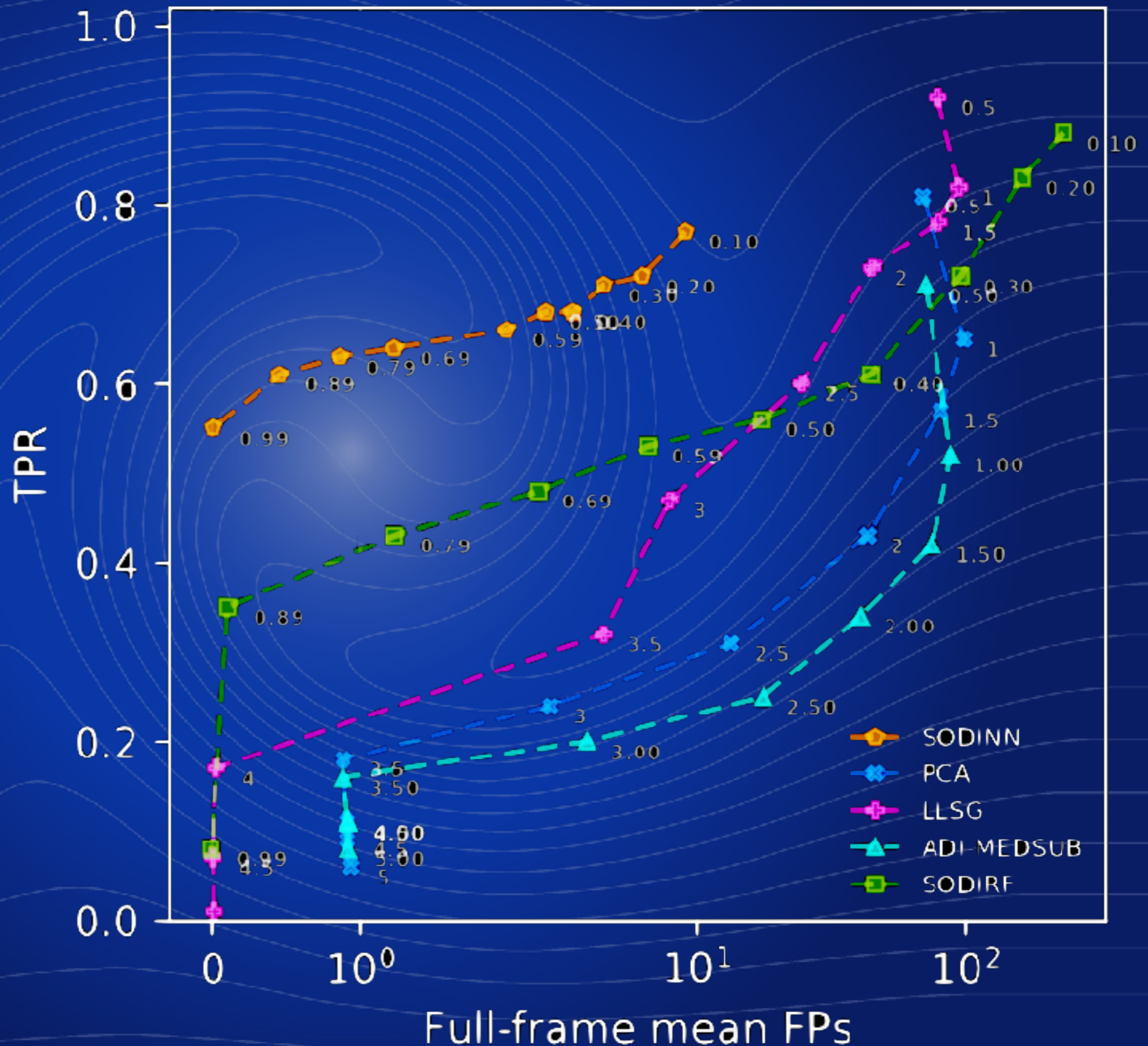



FUTURE PROJECTS

NEAR – NEW EARTH IN THE ALPHA CENTAURI REGION

- ▶ ESO project funded by Breakthrough Watch
 - * what? search for rocky planets around α Cen A&B
 - * how? refurbish VISIR and put it behind UT4+AOF
 - * when? 100h observing campaign in mid-2019
- ▶ vortex team contribution
 - * provide optimized AGPM for 10-12.5 μ m filter
 - * design optimized Lyot stop
 - * develop closed-loop pointing control with QACITS

NEAR LYOT STOP: TWO CHALLENGES

- ▶ binary target star
 - * need to dim secondary star
- ▶ complicated pupil

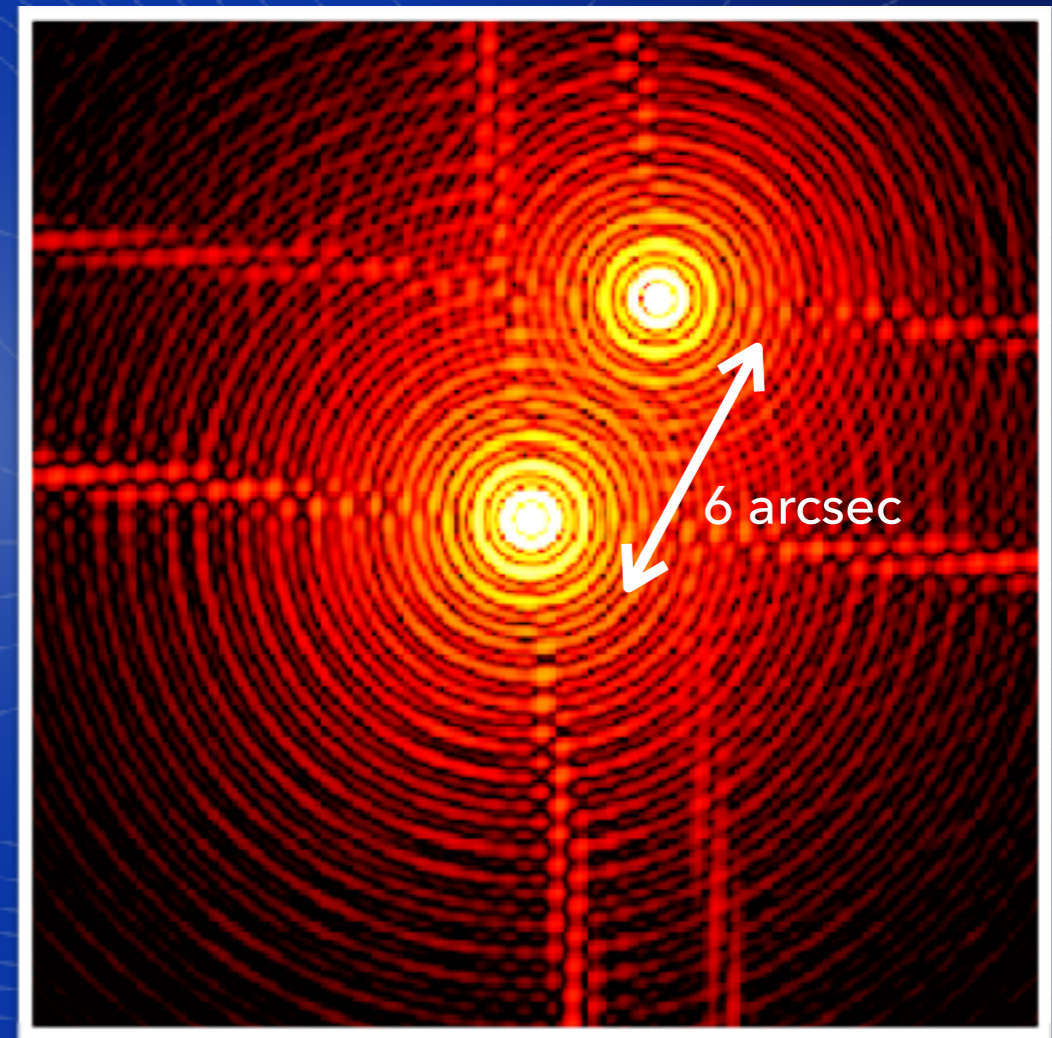
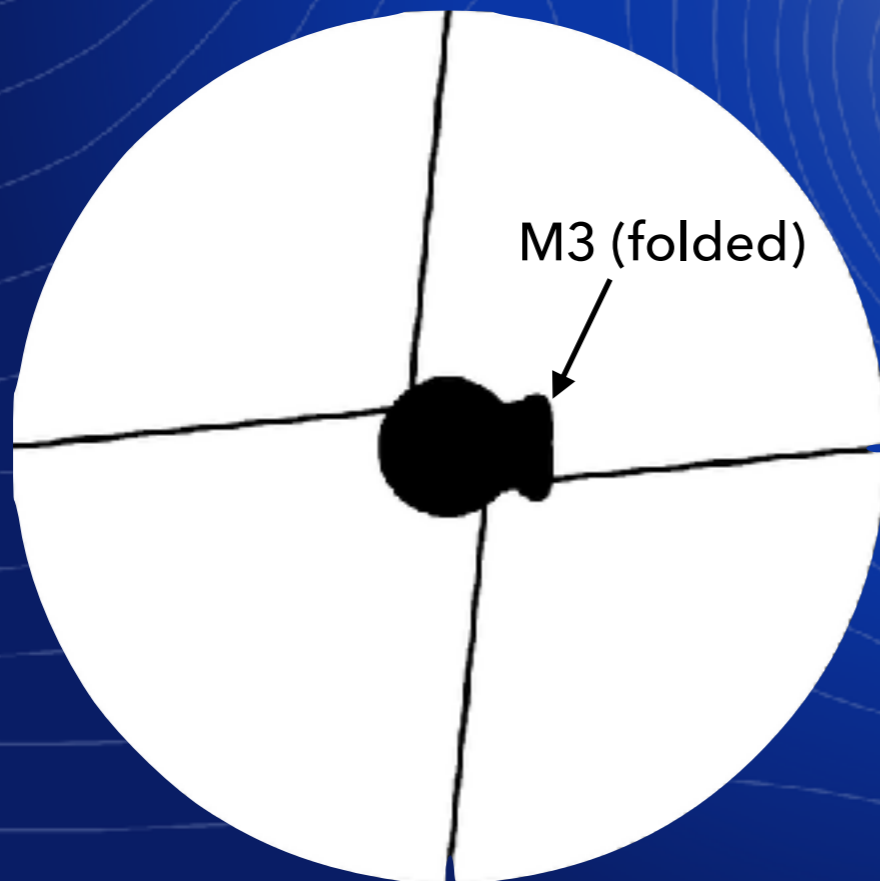

AN APODIZED LYOT STOP

- ▶ shaped-pupil: induce dark hole from 3" to 8" around B

Lyot stop



apodized Lyot stop

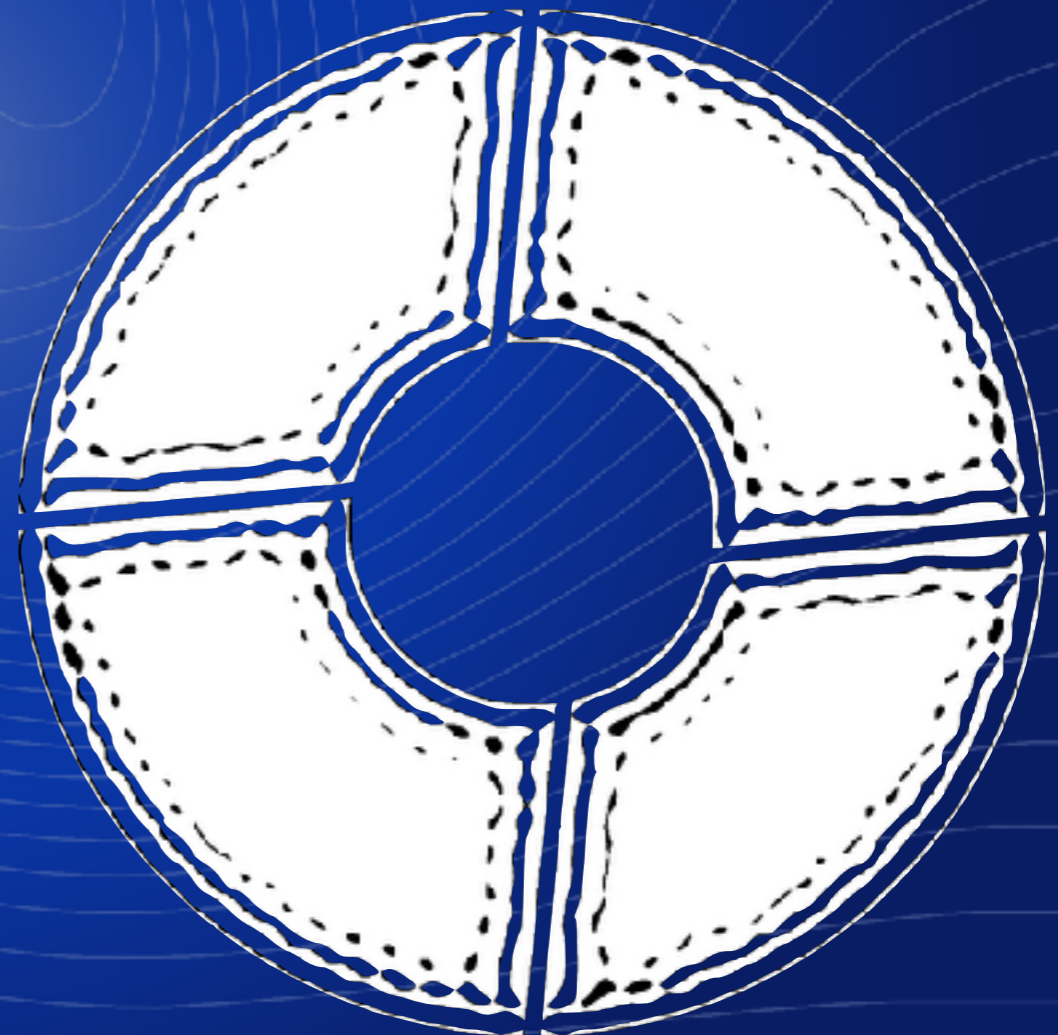

NOTIONAL IMAGES OF ALPHA CENTAURI SYSTEM

- ▶ habitable zone at $0.8'' - 1.1''$ (A) or $0.5'' - 0.65''$ (B)
- ▶ contrast around 10^{-6} for $2 R_{\oplus}$ planet

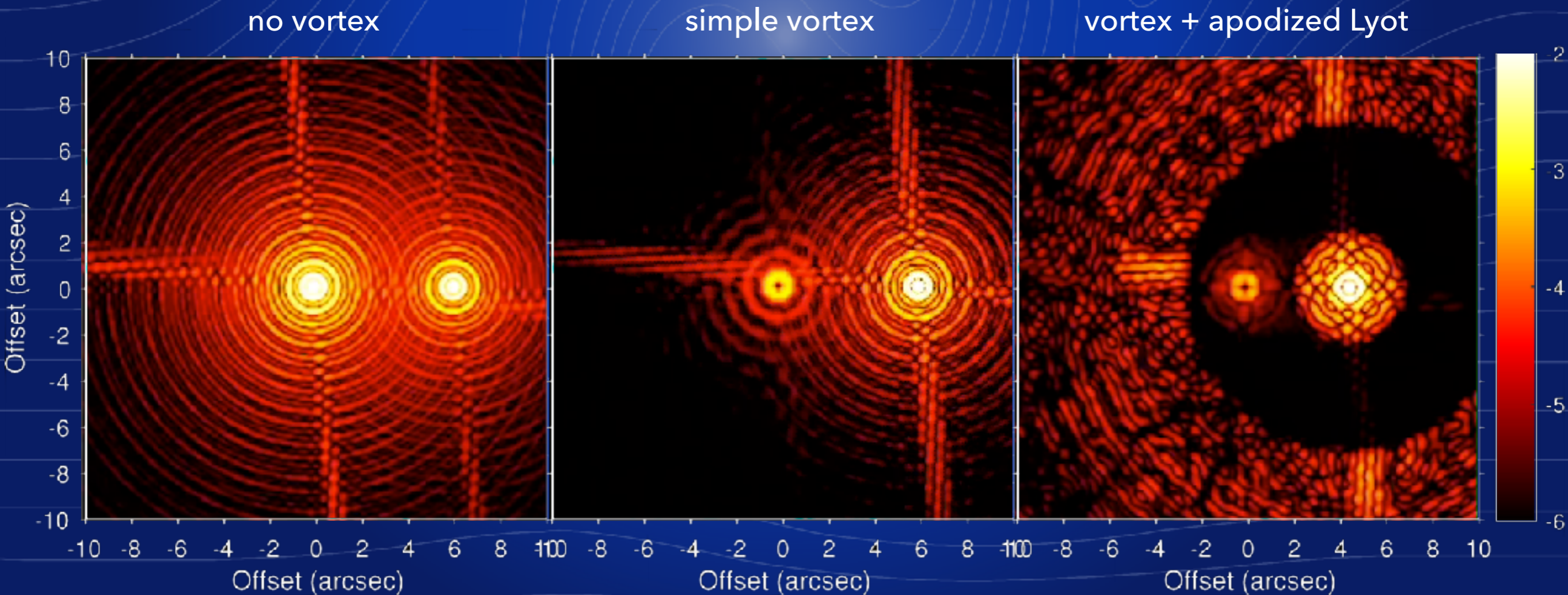

NEXT STEPS: VLT/ERIS AND ELT/METIS

▶ ERIS: L & M band AGPMs

- * standard vortex coronagraph with simple Lyot stop

▶ METIS: L, M & N band AGPMs

- * ring-apodized vortex coronagraph: cancels diffraction from huge central obstruction

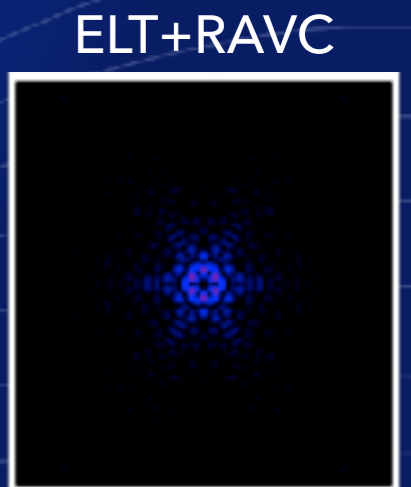
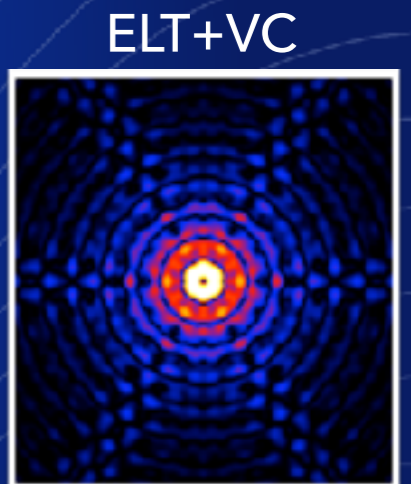
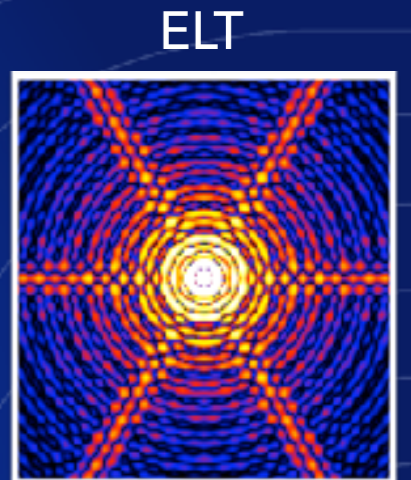

METIS SCIENCE HIGHLIGHTS

- ▶ direct imaging of several RV planets
- ▶ potential to detect temperate rocky planets
- ▶ characterization with high-res LM-band IFS

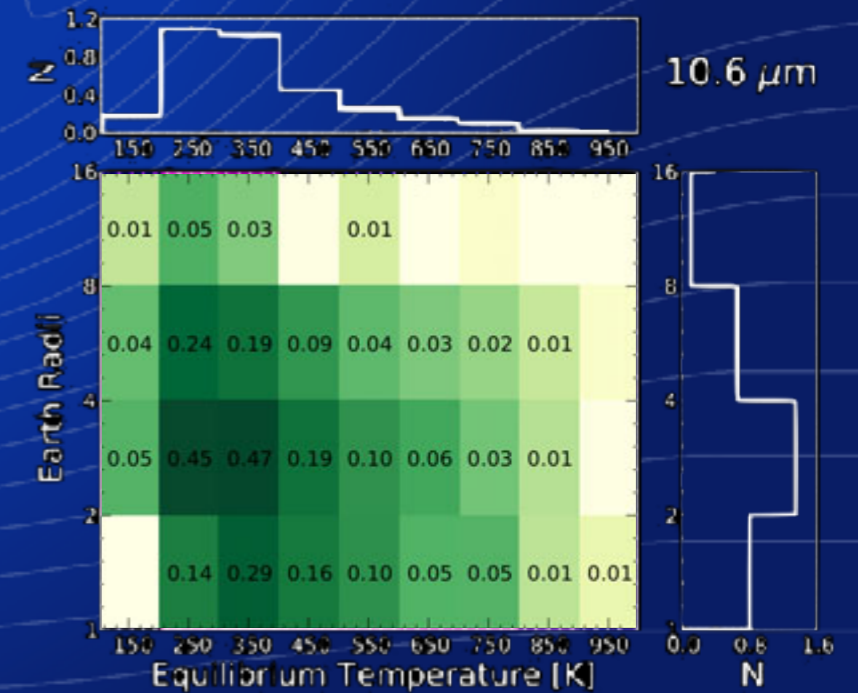
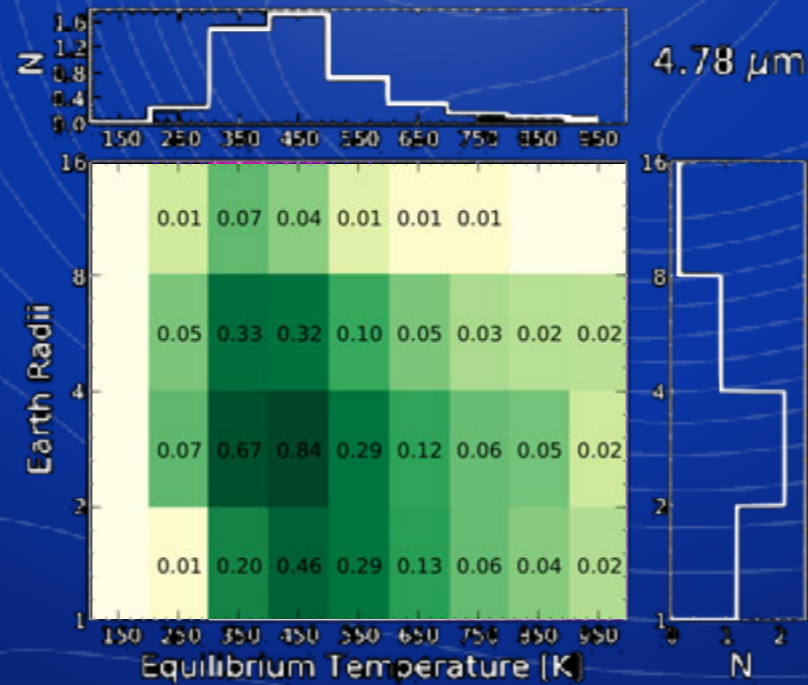
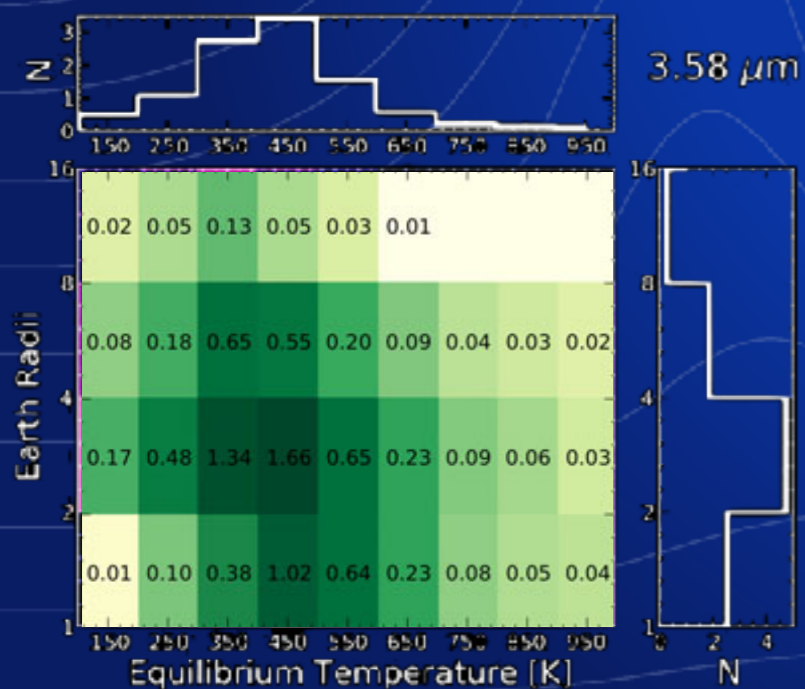

A VORTEX UPGRADE FOR SPHERE?

- ▶ goal: open the $1-3 \lambda/D$ parameter space
 - * increase number of detections
 - * access a few RV planets
- ▶ need to identify main limitations to FQPM performance
 - * component degradation?
 - * effect of dead actuators?
 - * low-order wavefront aberrations?
- ▶ K-band AGPM performance being evaluated

THANKS FOR YOUR ATTENTION

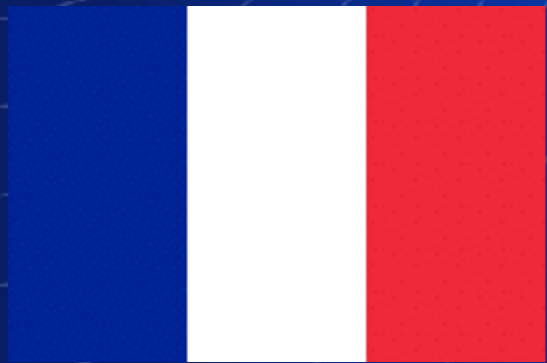

AND NOW . . . GAME ON!