

Techno-economic evaluation of self-consumption with PV/battery systems under different regulation schemes.

Sylvain Quoilin^a, Andreas Zucker^a

^a European Commission, DG Joint Research Center, Institute for Energy and Transport, P.O. Box 2, NL-1755 ZG Petten, The Netherlands

Abstract:

The recent disclosure of new and innovative home battery systems has been seen by many as a catalyser for a solar energy revolution, and has created high expectations in the sector. Many observers have predicted an uptake of combined PV/Battery units, which, could ultimately disconnect from the grid and lead to autonomous homes or mini-grids. However, most of the comments originating from social media, blogs or press articles lack proper cost evaluation and realistic simulations. This work aims at bridging this gap by simulating self-consumption in different EU countries, for different household profiles with or without battery. Results indicate that (1) Although decreasing at a fast pace, the cost of domestic Li-Ion storage is most likely still too high for a large-scale market uptake in Europe; (2) PV incentives based on net metering are not favourable to home batteries; (3) Home battery profitability and future uptake mainly depend on the indirect self-consumption subsidies provided by the structure of the retail prices; (4) These systems do not allow residential consumers to go off-grid. They only allow for a maximum self-sufficiency ratio close to 70%

Keywords:

Battery ,PV ,Self-Consumption ,Prosumer ,Household.

The views expressed are purely those of the authors and may not in any circumstances be regarded as stating an official position of the European Commission.

1. Introduction

The recent development and market entry of new home battery systems, together with significant price reductions, has been seen by many as a catalyser for a solar energy revolution, and has created high expectations in the sector. Many observers have predicted an uptake of combined PV/Battery units, which, according to them, could ultimately disconnect from the grid and lead to autonomous homes or microgrids.

A common mistaken assumption when evaluating the profitability of home battery systems is to assume a constant number of cycles over the battery life. This allows easily calculating the levelized cost of stored energy: if the battery lifetime is 10 year, a number of 3650 full cycles can be expected, which, once divided multiplied by the battery capacity and divided by the investment, can provide the levelized cost per stored kWh.

As shown later in this paper, this approach is erroneous because the number of full equivalent cycles is lower than one per day, and because it highly depends on the battery capacity: a small battery tends to perform almost one full cycle every day, while a large battery presents much more limited charge/discharge cycles.

This paper aims at providing solid indicators regarding the amount of self-consumption induced by solar home battery systems, by means of a high number of realistic simulations.

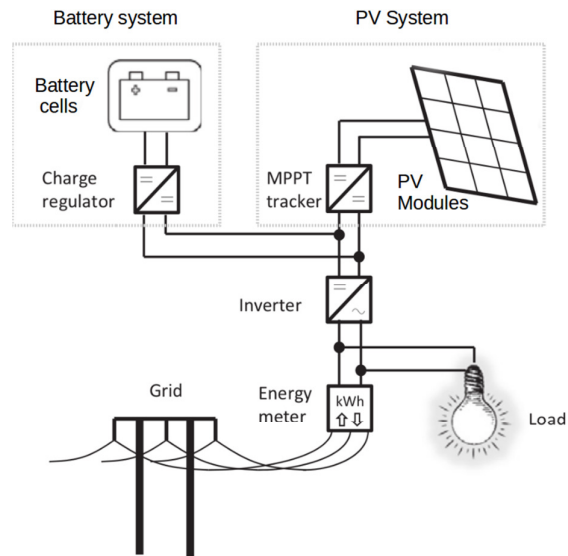

Fig. 1. Conceptual scheme of the considered DC-coupled system. Adapted from [1]

In a first step, a database of household 15-min electricity consumption profiles is gathered for the following countries: Belgium, Spain, Germany, Denmark, Hungary, Italy, Romania, France and United Kingdom. These consumption profiles are simulated in conjunction with a PV generation model and a simple battery model including degradation. Irradiation and temperature profiles are obtained from the typical meteorological year datasets.

In a second step, the amount of self-consumption is derived as a function of the relative sizes of the yearly demand, PV generation and battery capacity. This analysis is carried out for all household profiles, whose number is deemed sufficient to derive statistically significant values for the self-consumption and self-sufficiency rates.

The third part of the work evaluates the economic profitability of the systems as a function of the PV system and battery sizes, taking a particular regulatory framework into account. An optimization model is set up to maximize the system profitability from a user perspective, and sensitivity analyses are carried out to determine the influence of the battery cost.

2. Household consumption profiles

To properly evaluate the potential for self-consumption and the levelized cost of a home battery storage system, realistic time series of both the domestic electricity demand and PV production throughout the year should be used. This is necessary to account for the match or the mismatch between solar generation and household consumption at any moment of the day. This analysis should moreover distinguish several geographical areas since the different load patterns between countries impact the amount of self-consumption: warmer climates are associated with a higher cooling loads, and therefore present a better match between solar insolation and electricity consumption. This effect will be detailed in the next sections.

Given the stochasticity of consumption and production profiles, a reliable value of the self-consumption indicators can only be computed from a statistical analysis taking a large number of consumption/production profiles into account. The main challenge is the lack of easily accessible data for household consumption profiles in different EU countries. Most of the published data is aggregated over a large number of households (standard load profiles) and therefore smooths out the variability of the individual profiles. To achieve results that are scientifically sound, a significant number of monitored consumption profiles has been gathered, and some additional stochastic profiles have been generated where data was missing.

Historical household consumption data is scarce in the open-scientific literature or in open-data portals. Some source are available from the field of machine learning and Non Intrusive Load

Monitoring (NILM): open datasets are released to test and train the models, and provide household consumption profiles with a high time resolution.

Household consumption profiles are available for a different EU Countries as a result of the REMODECE EU project . This dataset is particularly interesting because of the large number of monitored households (> 850). Its main drawback, however, is that the provided load profiles are hourly profiles for one typical day in the month: as a result of the aggregation into average days, the fast stochastic variations are lost, which might impact the evaluation of self-consumption. Therefore in this paper, stochastic noise is added on top of the typical daily profiles.

Each household consumption profile is simulated with typical irradiation profiles for the country they correspond to. To that end, a simple PV model is used, assuming a south orientation and a tilt angle of 35°. The annual output is corrected by a linear scaling to match the annual capacity factor number provided by the JRC PVGIS information system [8].

Table 1. Historical household consumption profiles

Dataset	Location	$N_{profiles}$	Period	Ref.
UKDA	UK	22	2008-2009	[3,4]
FR	France	1	2006-2010	[2]
SustData	Portugal	13	2010-2011	[5]
REMODECE	EU	850	2006-2008	[6]

2. PV and battery dispatch model

The dispatch of the storage capacity is performed in such a way to maximize self-consumption; the battery is charged when the PV power is higher than the load and as long as it is not fully charged. It is discharged as soon as the PV power is lower than the load and as long as it is not fully discharged. The losses that are taken into account are the battery round-trip efficiency and the inverter efficiency. It is also assumed that demand is not responsive.

At each timestep, the following simple dispatch algorithm is executed: The maximum battery discharge power is calculated by:

$$P_{max,dis,i} = \min\left(P_{max,bat}, \frac{SOC_{i-1} \cdot \eta_{bat}}{\Delta t}\right)$$

And the maximum charging power by:

$$P_{max,ch,i} = \min\left(P_{max,bat}, \frac{CAP_{bat} - SOC_{i-1}}{\Delta t}\right)$$

The actual battery discharge is computed by comparing the PV generation with the load:

$$P_{dis,i} = \min\left[P_{max,dis,i}, \max\left(0, \frac{P_{load,i}}{\eta_{inv} - P_{PV,DC,i}}\right)\right]$$

The actual battery charging power is calculated in a similar manner:

$$P_{ch,i} = \min\left[P_{max,ch,i}, \max\left(0, P_{PV,DC,i} - \frac{P_{load,i}}{\eta_{inv}}\right)\right]$$

The energy balance is finally written:

$$SOC_i = SOC_{i-1} + P_{ch,i} \cdot \Delta t - \frac{P_{dis,i}}{\eta_{bat}} \cdot \Delta t$$

Figure 2 illustrates the results of the dispatch algorithm for a typical week of July and a French historical consumption profile. Battery charging and feeding to the grid are indicated as negative values.

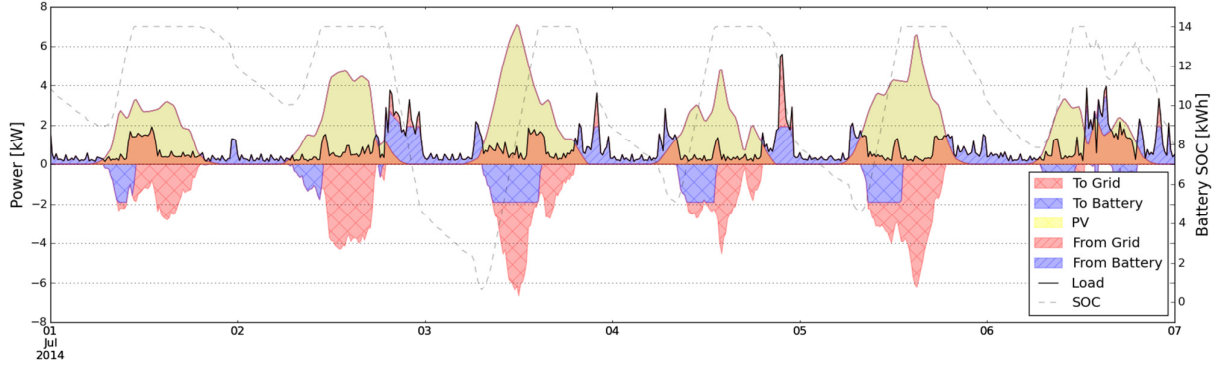

Fig. 2. Results of the battery dispatch

3. Yearly simulations

Combining the PV generation model, the demand profiles and the battery dispatch algorithm, it is straightforward to simulate a whole year of operation and generate time vectors of the battery state of charge or of the power bought and sold to the grid. The different models and data processing are implemented in the Python language. The dispatch algorithm is compiled using Cython to improve the computational efficiency of the yearly simulation. The different scripts developed in the present work are provided as electronic annexes of this paper.

3.2. Yearly energy flows

When performing a yearly simulation, the main variable of interest is the total amount of self-consumption. This variable is commonly expressed as a Self-Sufficiency Rate (SSR) or a Self-Consumption Rate (SCR) [9] (also referred to as solar fraction or load fraction by other authors [10]). In this work, the self-sufficiency rate is defined as the ratio between the self-consumed energy and the total yearly energy demand:

$$SSR = \frac{E_{SC}}{E_{load}} = \frac{\sum_{i=1}^N (P_{dis,i} + P_{SC,DC,0,i}) \cdot \eta_{inv}}{\sum_{i=1}^N P_{load,i}}$$

where E refers to an annual energy flow and P to an instantaneous Power. N is the number of time steps in one year and $P_{SC,DC,0,i}$ is the DC PV generation directly self-consumed (i.e. without passing through the battery).

The self-consumption rate is defined in a similar manner. Note that the reference is the annual energy produced by the PV array on the DC bus (i.e. before the inverter):

$$SCR = \frac{E_{SC}}{E_{PV,DC}} = \frac{\sum_{i=1}^N (P_{dis,i} + P_{SC,DC,0,i}) \cdot \eta_{inv}}{\sum_{i=1}^N P_{PV,DC,i}}$$

A summary of the relevant yearly energy flows is shown in Figure 3. Interestingly, each of these values can be deduced from the yearly demand E_{load} and from the value of SSR computed with or without battery.

To demonstrate this, the value self-sufficiency without battery must be defined. This is achieved through the SSR_0 variable, defined as:

$$SSR_0 = \frac{E_{SC,0}}{E_{load}} = \frac{\sum_{i=1}^N P_{SC,DC,0,i} \cdot \eta_{inv}}{\sum_{i=1}^N P_{load,i}}$$

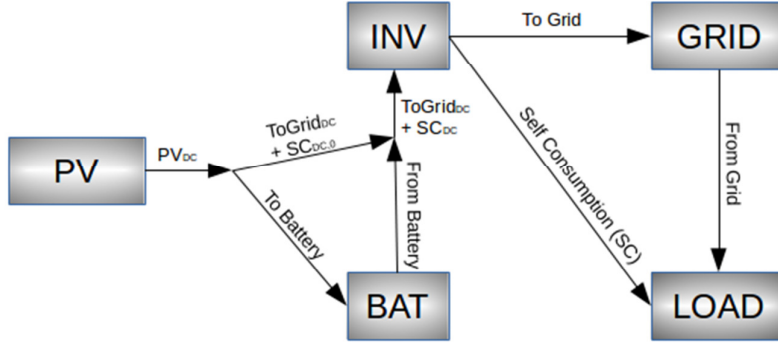

Fig 3. Energy Flows on a yearly basis

The relative PV system and battery sizes are defined as inputs of the simulation since they influence the different energy flows and the amount of self-consumption. They are normalised to the annual electricity demand:

$$R_{bat} = \frac{CAP_{bat} \text{ [kWh]}}{E_{load} \text{ [MWh]}}$$

where CAP_{bat} is the accessible battery capacity (i.e. the total battery capacity multiplied by the maximum depth of discharge).

The relative PV size is defined using the annual generation of the PV array on the DC bus (i.e. before inverter):

$$R_{PV} = \frac{E_{PV,DC}}{E_{load}} = \frac{P_{PV,peak} \cdot \eta_{inv} \cdot CF_{PV}}{E_{load}} \left[\frac{\text{kWh}}{\text{kWh}} \right]$$

where $P_{PV,peak}$ is the peak power (in kWp) of the PV system in the standard conditions and CF_{PV} is the capacity factor of the PV installation for the given location, in kWh/kWp. SCR can be deducted from SSR and the PV system capacity:

$$SCR = \frac{SSR}{R_{PV}}$$

The total amount of energy provided by the battery is the self-consumption minus the self-consumption in the case without battery:

$$E_{FromBat} = E_{SC,DC} - E_{SC,DC,0} = \frac{E_{SC} - E_{SC,0}}{\eta_{inv}}$$

The amount of electricity sold to the grid is what remains from the PV production after removing the self-consumed energy flows:

$$E_{ToGrid} = \eta_{inv} \left(E_{PV,DC} - E_{SC,DC,0} - \frac{E_{FromBat}}{\eta_{bat}} \right)$$

From the above equations, it appears that the most important indicator is SSR, all the other ones being deducted from it. Therefore, the next paragraphs will focus on the influence of the different operating parameters on its value.

3.2. Direct self-consumption

This section focuses on the case of household self-consumption with a PV system but without battery. One of the goals of this analysis is to cross-check the very common hypothesis of a 30% self-sufficiency rate. To that aim, the entire database of synthetic and historical profiles is simulated using the algorithm described above. For these simulation, it is assumed that $R_{PV} = 1$. The simulation time step is 15 min and the total number of simulated profiles is 929. The results of the simulations are shown in Figure 4.

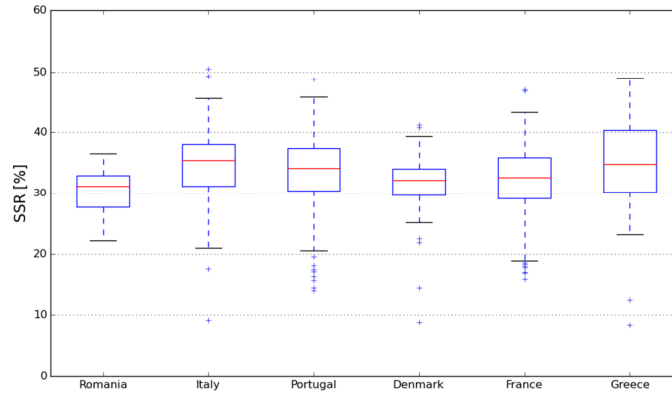

Fig 4. Box plot of the Self-sufficiency rate for each country (PV/demand ratio: 1)

The following conclusions can be drawn from Figure 4:

- The standard deviation is high. The self-consumption can therefore be only evaluated in a probabilistic way for a given household.
- The assumption $SSR_0 = 30\%$ seems to slightly underestimate the actual numbers obtained in this analysis. It can therefore be considered as a conservative hypothesis.
- Southern countries tend to present a slightly higher self-consumption rate, probably due to the good correlation between cooling demand and solar irradiation.
- The average difference between countries is however much smaller than the standard deviation within a country.

3.2. Influence of the battery capacity

Adding a battery to the system allows increasing the self-consumption. However, each additional storage unit within the system presents an utilization rate lower than the previous one. This effect is illustrated by performing the same simulation as above and varying the battery size (Figure 5). As expected, the curve seems to present a horizontal asymptote: after a certain quantity, any additional kWh of battery storage only increases marginally the SSR value: at high capacity, the battery storage starts to balance longer variations than daily variations (e.g. weekly or seasonal variations), which occur less frequently and therefore contribute less to increase the Self-sufficiency rate.

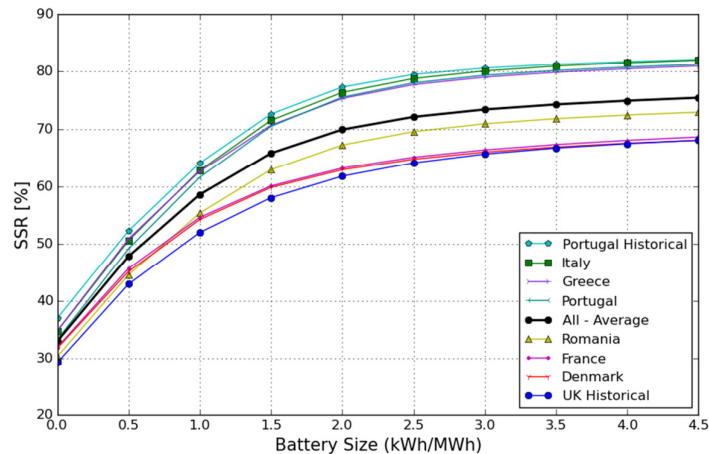

Fig 5. Influence of the battery size on the self-sufficiency rate for each country (PV/demand ratio: 1)

The following conclusions can be drawn from Figure 5:

- The difference between countries $R_{bat} = 0$ seems to increase with the battery capacity.
- Interestingly, the only country for which both synthetic and historical profiles are available (Portugal) shows a good agreement between both curves, which tends to indicate that the generated stochastic profiles are suitable for such simulation.

4. Bivariate regression

The main goal of this section is to provide a tool for the prediction of the self-sufficiency rate as a function the PV system and battery sizes. This kind of tool is particularly useful when evaluating the profitability of such systems because it allows calculating the amount of energy self-consumed, sold to the grid and bought from the grid. It should be simple to implement, accurate and computationally efficient.

As in the monivariate analysis, the dispatch algorithm is first run for all the household profiles and for an array of R_{PV} and R_{bat} values. The SSR surfaces are then averaged for one geographical area or for the whole set of profiles. Figure 6 shows the result of this procedure in the case including all profiles.

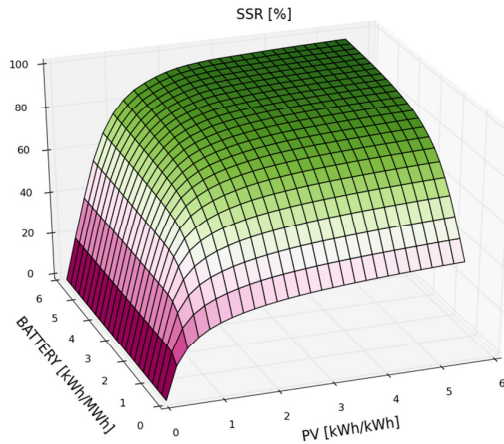

Fig 6. Influence of the PV system and battery sizes on the Self-Sufficiency Rate

The challenge is to fit a 2-dimensional function to the SSR surface that presents the following characteristics:

- Good overall accuracy between the model and the original values
- Exact number for SSR_0 with $R_{PV} = 1$ since this value is very commonly used
- Excellent accuracy for the prediction of SSR versus R_{PV} with $R_{bat} = 0$ since it corresponds to the common case of the absence of battery
- Excellent accuracy for the prediction of SSR versus R_{bat} with $R_{PV} = 1$ since this is a also a common case
- $SSR \rightarrow 100\%$ for $R_{PV} \rightarrow \infty$ or $R_{bat} \rightarrow +\infty$
- $SSR \rightarrow 0$ if $R_{PV} \rightarrow 0$

The shape of the univariate curves SSR vs R_{PV} (Figure 7) or SSR vs R_{bat} (Figure 5) is nearly asymptotical at SSR=100%. It can be fairly well approximated by a hyperbolic tangent function (also presenting an horizontal asymptote) combined with a linear term.

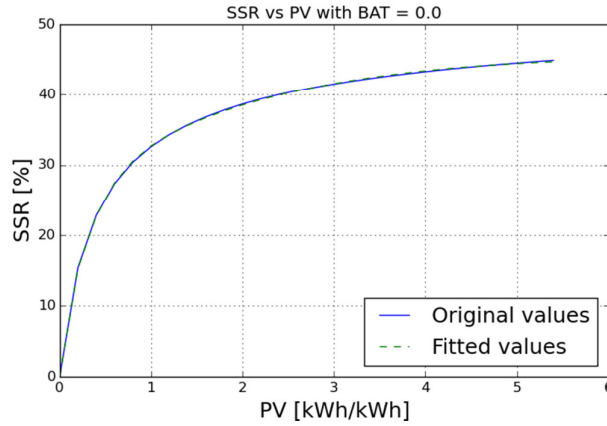

Fig 7. SSR_0 as a function of the PV size fitted with a hyperbolic function

Since the SSR data points (Figure 7) don't present the same importance, a 3-steps regression methodology is proposed:

First, a reference value of SSR is obtained directly from the data and imposed to the further steps:

$$SSR_{0,1} = SSR_{R_{bat}=0, R_{PV}=1}$$

Then, the univariate curves at $R_{PV} = 1$ and $R_{bat} = 0$ are fitted using the following analytical expressions:

$$SSR_{R_{PV}=1} = SSR_{0,1} + a_1 \cdot \tanh(a_2 \cdot R_{bat}) + a_3 \cdot R_{bat}$$

$$SSR_{R_{bat}=0} = b_4 \cdot \tanh(b_5 \cdot R_{PV}) + b_6 \cdot R_{PV} + b_7 \cdot \sqrt{R_{PV}}$$

where a_i and b_i are the coefficients determined by minimizing the Root Mean Square Error (RMSE) between the function and the data. These coefficients should remain positive to ensure that SSR grows monotonously with R_{bat} and R_{PV} .

Finally, the 2D regression is performed by imposing the two univariate curves (coefficients $a_{1 \rightarrow 3}$ and $b_{4 \rightarrow 7}$) and by fitting additional coefficients $c_{8 \rightarrow 15}$. In order to increase the accuracy, the regression procedure is split in two ($R_{PV} \leq 1$ and $R_{PV} > 1$). The final expression of the regression is given by:

If $R_{PV} \leq 1$:

$$SSR = \begin{aligned} & W \cdot [SSR_{0,1} + a_1 \cdot \tanh(a_2 \cdot R_{bat}) + a_3 \cdot R_{bat} \\ & \quad + (c_{12} \cdot \tanh(c_{13} \cdot (1 - R_{PV})) \cdot R_{PV} \\ & \quad + (1 - W) \cdot \max[R_{PV}, (b_4 \cdot \tanh(b_5 \cdot R_{PV}) \\ & \quad \cdot (1 + c_{14} \cdot \tanh(R_{bat})) + c_{15} \cdot \tanh(R_{bat})] \end{aligned}$$

If $R_{PV} > 1$:

$$SSR = \begin{aligned} & W \cdot [SSR_{0,1} + a_1 \cdot \tanh(a_2 \cdot R_{bat}) + a_3 \cdot R_{bat} \\ & \quad + (c_8 + c_9 \cdot R_{bat}) \cdot \tanh(c_{10} \cdot (R_{PV} - 1)) \\ & \quad + c_{11} \cdot (R_{PV} - 1)] \\ & \quad + (1 - W) \cdot \max[R_{PV}, (b_4 \cdot \tanh(b_5 \cdot R_{PV}) \\ & \quad \cdot (1 + c_{14} \cdot \tanh(R_{bat})) + c_{15} \cdot \tanh(R_{bat})] \end{aligned}$$

where W is a weighting function given by:

$$W = \min[1, \max(0, R_{bat})]$$

A total of 15 empirical coefficients is necessary to ensure that the regression fulfils the requirements. These coefficients are provided in Table 2 for three different cases representative of the results obtained in this study: a southern European country (Portugal), the average for all countries and a northern European country (Denmark). The quality of the regression can be evaluated using the coefficient of determination, leading to $R^2 = 99.84\%$ for the overall average, $R^2 = 99.87\%$ for Portugal and $R^2 = 99.91\%$ for Denmark, which is deemed acceptable.

Table 2. Coefficients of the fSSR function

	Average	Portugal	Denmark
$SSR_{0,1}$	32.603	33.438	32.184
a_1	38.220	47.093	30.685
a_2	0.854	0.715	0.844
a_3	1.019	0.081	0.968
b_4	13.268	15.802	11.238
b_5	2.092	2.496	2.120
b_6	-4.760	-4.463	-5.381
b_7	24.589	22.350	26.751
c_8	8.998	9.459	10.694
c_9	1.742	1.245	1.516
c_{10}	1.379	1.347	0.841
c_{11}	1.221	0.954	1.854
c_{12}	34.320	22.511	67.400
c_{13}	1.459	2.676	0.782
c_{14}	0.373	0.282	0.441
c_{15}	15.027	16.318	8.756

The implementation of the final function can be cross-checked with the following values (in the “Average” case):

$$SSR_{R_{bat}=0.8, R_{PV}=0.8} = 51.76131\%$$

$$SSR_{R_{bat}=1.2, R_{PV}=1.2} = 66.55241\%$$

5. Economic evaluation

This section illustrates how the analytical expression derived above can be used to optimize and evaluate the profitability of PV/battery home system, taking into account the benefits of self-consumption.

Figure 8 describes the rationale behind the maximization of the self-sufficiency rate for a prosumer. Germany is taken as an example because its tariff structure is usually seen as favourable to solar home batteries: the price difference between buying electricity (at the retail price) and selling electricity (at the feed-in-price) is high, which can justify investing into self-consumption.

In such a context, households optimize their solar home battery investment by comparing the levelized cost of storage and of the PV installation to the residential electricity tariff that includes network tariffs, taxes, levies and other surcharges that can be avoided when consuming self-produced PV electricity instead of purchasing electricity from the grid. This can be seen as an indirect financial incentive to self-consumption originating from the tariff structure.

It should be noted that, in a scenario in which such systems undergo a significant uptake, this mechanism is unsustainable since it generates revenue shortfalls for government, municipalities and system operators. These losses of revenues need to be somehow compensated, either by increasing the network tariffs or by changing the tariff structure, e.g. switching from a volume (i.e. per kWh) remuneration to a fixed or to a capacity remuneration for the grid connection. Interestingly, this modification of the tariff structure is already ongoing in various EU countries [11].

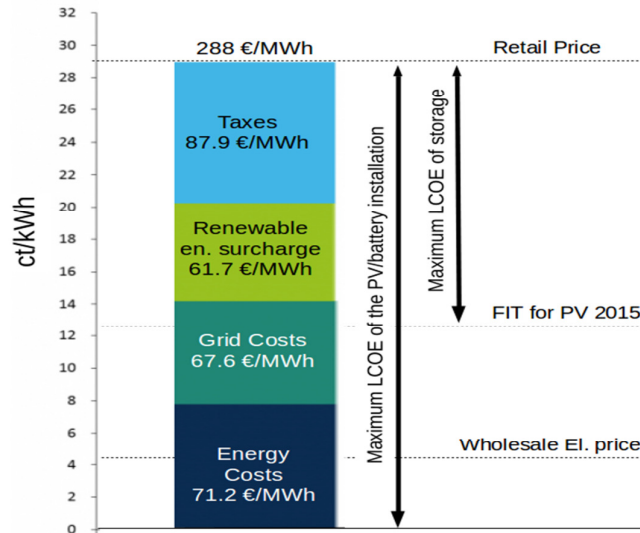

Fig 8. Average retail tariff structure in Germany (2015) and impact on self-consumption

From a user perspective the levelized cost of a grid-connected solar home battery system can be calculated by considering the grid as a zero-investment generator producing at the retail price. In that case, the energy fed to the grid should also be taken into account as a negative cost.

The investment in the battery and PV systems is taken into account as a constant annuity:

$$A = \left(I_{PV} + I_{bat} * \left[1 + \frac{1}{(1+i)^{N_{bat}}} \right] \right) \cdot (CRF + OM)$$

where A is the annuity, I states for investment and where it is assumed that there is a second investment in the battery after N_{bat} years. OM is the fraction of annual operation and maintenance. CRF is the capital recovery factor calculated by:

$$CRF = \frac{i \cdot (1+i)^{N_{PV}}}{(1+i)^{N_{PV}} - 1}$$

where i is the weighted average cost of capital (WACC) and N_{PV} is the PV system lifetime in years.

The Levelized Cost of Electricity from a prosumer perspective can be defined as:

$$LCOE = \frac{A + E_{FromGrid} \cdot P_{Retail} - E_{ToGrid} \cdot P_{ToGrid}}{E_{load}}$$

It is also interesting to isolate the contribution of the battery by calculating the Levelized Cost of Storage (LCOS):

$$LCOS = \frac{A_{bat}}{E_{FromBat}}$$

where A_{bat} is the part of the annuities linked to the battery investment and re-investment.

Figure 9 displays the influence of the PV system and battery sizes on the LCOE value for the following conditions:

- $WACC = 4.16\%$
- $N_{bat} = 10, N_{PV} = 20$
- Fixed and variable costs of the battery system: 300EUR, 200EUR/kWh
- Variable costs of the PV system: 1500 EUR/kWp
- Operation and maintenance: 1.5% of investment.

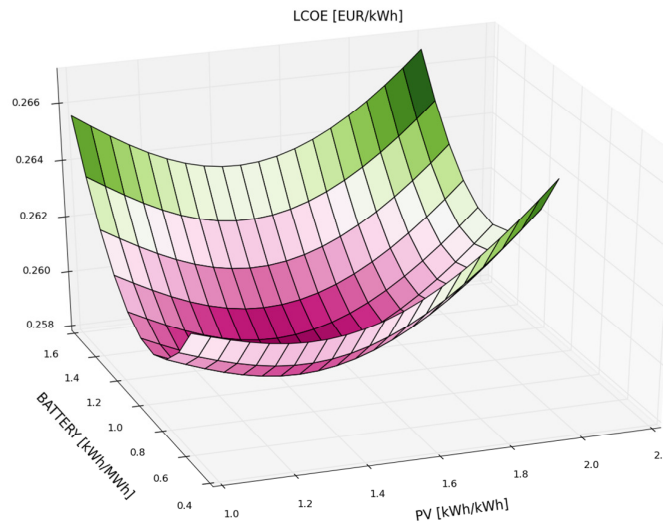

Fig 9. LCOE as a function of the PV system and battery sizes

An optimum clearly appears, both in terms of PV size and battery size: if the battery is oversized, its utilization is low, which leads to excessive investment costs. On the other hand, for small batteries, the amount of displaced load is low and the impact on the self-consumption is marginal. The same is true for the PV system, whose revenues are significantly higher for the self-consumed share of the production than for the one fed to the grid. The design of such a system can therefore be expressed as Mixed-Integer Non Linear Programming (MINLP) optimization problem.

6. Conclusions

The main objective of this work was to evaluate the amount of self-consumption that can be expected for a household installing a PV system with or without battery. To be relevant, such analysis can only be performed for a large number of different (stochastic) household consumption profiles. A database of profiles has therefore been gathered from monitoring data, and a number of additional stochastic profiles have been generated.

The analysis has revealed the following:

- The inter-household variability of the self-sufficiency rate is high. For a given household, the amount of self-consumption can therefore not be predicted in a deterministic way.
- For an average European household, the self-sufficiency rate in the absence of battery varies between 30 and 37%. The value tends to be slightly higher in southern countries.
- SSR as a function of the PV and Battery sizes is a non-linear, almost asymptotic function. Achieving 100% self-consumption (i.e. allowing for full off-grid operation) is not realistic without excessively oversizing the PV system and/or the battery.
- The self-sufficiency rate can be significantly impacted by the maximum charging and discharging power of the battery, especially for high battery capacities.
- The benefits of self-consumption originate from the tariff structure and the difference between the buying and selling prices of electricity. They are therefore largely linked to the local regulation. A scenario of high penetration of self-consumption solutions might lead to an unfair distribution of network charges, taxes and levies since they are not paid for by self-consumers.
- Depending on the financial inputs, optimum PV and battery sizes can exist: adding a battery to the system can result in a larger optimum PV array size.

It should finally be noted that the economic analysis presented in this work is for illustrative purpose mainly. It does not aim at covering the full spectrum of possible regulations and market tariffs. It can therefore not be considered as a comprehensive evaluation of the profitability of home batteries. Future works will focus on the exploitation of the self-consumption evaluation tool for

policy support, in particular to evaluate the impact of the current evolutions in EU regulations on self-consumption and on the future deployment of solar home battery systems.

References

- [1] R. Luthander, J. Widn, D. Nilsson, J. Palm, Photovoltaic self-consumption in buildings: A review, *Applied Energy* 142 (2015) 80–94. doi:10.1016/j.apenergy.2014.12.028.
- [2] G. Hebrail, UCI Machine Learning Repository: Individual household electric power consumption Data Set, Tech. rep., University of California, Irvine, School of Information and Computer Sciences, 00002 (2012).
- [3] I. Richardson, M. Thomson, D. Infield, C. Clifford, Domestic electricity use: A high-resolution energy demand model, *Energy and Buildings* 42 (10) (2010) 1878–1887. doi:10.1016/j.enbuild.2010.05.023.
- [4] I. Richardson, M. Thomson, One-Minute Resolution Domestic Electricity Use Data, 2008-2009, Tech. Rep. <http://dx.doi.org/10.5255/UKDA-SN-6583-1>, 2016. URL <http://ckan.data.alpha.jisc.ac.uk/dataset/6583>
- [5] F. Lucas Pereira, R. Quintal, J. N. Nuno, SustData: A Public Dataset for ICT4s Electric Energy Research, in: *Proceedings of the second International Conference on ICT for Sustainability*, Stockholm, Sweden, 2014.
- [6] J. Dupret, Residential Monitoring to Decrease Energy Use and Carbon Emissions, Tech. rep., University of Coimbra, Portugal (2008) URL <http://remodece.isr.uc.pt/>
- [7] J. M. Nichols, C. C. Olson, J. V. Michalowicz, F. Bucholtz, A simple algorithm for generating spectrally colored, non-Gaussian signals, *Probabilistic Engineering Mechanics* 25 (3) (2010) 315–322. doi:10.1016/j.probengmech.2010.01.005.
- [8] A. G. Amillo, T. Huld, R. Mller, A New Database of Global and Direct Solar Radiation Using the Eastern Meteosat Satellite, *Models and Validation, Remote Sensing* 6 (9) (2014) 8165–8189. doi:10.3390/rs6098165.
- [9] J. Weniger, T. Tjaden, V. Quaschnig, Sizing of Residential PV Battery Systems, *Energy Procedia* 46 (2014) 78–87, 00023
- [10] J. Munkhammar, P. Grahn, J. Widn, Quantifying self-consumption of on-site photovoltaic power generation in households with electric vehicle home charging, *Solar Energy* 97 (2013) 208–216. doi:10.1016/j.solener.2013.08.015.
- [11] Best practices on Renewable Energy Self-consumption, COMMISSION STAFF WORKING DOCUMENT COM(2015) 339 final, European Commission, Brussels (Jul. 2015).
- [12] L. Goldie-Scot, Cost reductions and residential energy storage drivers, Tech. rep., Bloomberg (Jan. 2016).