

# Model-Based Decision Support Algorithm to Guide Fluid Resuscitation <sup>\*</sup>

Antoine Pironet <sup>\*</sup> Pierre C. Dauby <sup>\*</sup> Philippe Morimont <sup>\*</sup>  
Nathalie Janssen <sup>\*\*</sup> J. Geoffrey Chase <sup>\*\*\*</sup> Shaun Davidson <sup>\*\*\*</sup>  
Thomas Desaive <sup>\*</sup>

<sup>\*</sup> *GIGA-In Silico Medicine, University of Liège, Liège, Belgium  
(e-mail: a.pironet@ulg.ac.be).*

<sup>\*\*</sup> *GIGA-Cardiovascular Sciences, University of Liège, Liège, Belgium.*

<sup>\*\*\*</sup> *Department of Mechanical Engineering, University of Canterbury,  
Christchurch, New Zealand*

**Abstract:** Fluid resuscitation is the first choice therapy for septic shock. However, fluid infusion only increases cardiac output in approximately 50 % of cases, while an excess of fluid can have harmful effects. Therefore, clinicians are looking for indices to predict the effect of fluid infusion on cardiac output, before giving fluid.

In this work, a minimal mathematical model of the cardiovascular system is used, representing the heart, an artery and a vein. The nine model parameters, including total stressed blood volume, are identified from experimental data. The experimental data was recorded during three 500 ml fluid infusions on two pigs infected with endotoxin, to simulate septic shock.

The total stressed blood volume parameter is negatively associated with the change in cardiac output after fluid infusion, as observed in previous studies. Subsequently, an algorithm is proposed to guide fluid resuscitation, based on the value of this parameter. The use of the algorithm results in 60 % less fluid being given with virtually no effect on cardiac output.

The decision algorithm has the potential to be used in human clinical trials since the data required for parameter identification can be obtained in an intensive care unit.

*Keywords:* parameter identification, mathematical models, medical applications.

## 1. INTRODUCTION

Septic shock is a life-threatening condition caused by an infectious agent. The associated inflammatory response modifies the blood vessels properties and causes a leakage of fluid out of the vessels that reduces perfusion (Gupta et al., 2015). In addition, vaso-motor and pressure control can be reduced. Consequently, the oxygen demand of the organs cannot be met by the cardiovascular system (CVS).

Fluid infusion is the first therapy to restore correct fluid balance in septic shock (Gupta et al., 2015). However, fluid infusion increases cardiac output (CO) in only approximately 50 % of the cases (Maas et al., 2012). In addition, excess fluid can be harmful by increasing capillary hydrostatic pressure and worsening interstitial oedema. Clinicians are thus looking for reliable indices of fluid responsiveness. Such indices must be able, before giving fluid, to predict the change in CO following a fluid infusion.

Pironet et al. (2015) previously introduced a simple three-chamber CVS model whose parameters could be identified from intensive care unit (ICU) data. Total stressed blood volume (SBV), defined as the total pressure-generating blood volume in the CVS is one parameter of that CVS model. Using data from healthy pigs, Pironet et al. (2015)

<sup>\*</sup> This work was supported by the French Community of Belgium, the Belgian Funds for Scientific Research (F.R.S.-FNRS) and EU Marie Curie Actions (FP7-PEOPLE-2012-IRSES).

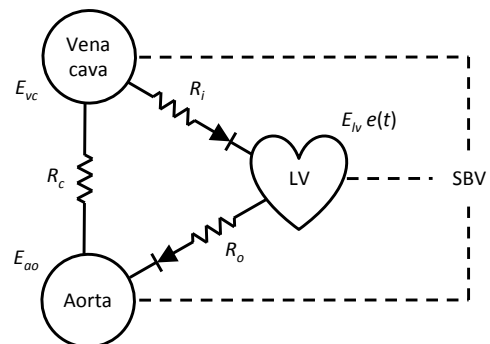

Fig. 1. Schematic representation of the CVS model.

showed that SBV was consistently associated with changes in CO after fluid infusion. This work investigates whether this association still holds in pathologic situations, using experimental data from infected pigs.

## 2. METHODS

### 2.1 Cardiovascular System Model

The CVS model used in this work is presented in Fig. 1. It consists of three elastic chambers representing the left ventricle (*lv*), the aorta (*ao*) and one vena cava (*vc*). The aorta and the vena cava are described by:

$$P_{ao}(t) = E_{ao} V_{S,ao}(t) \quad (1)$$

$$P_{vc}(t) = E_{vc} V_{S,vc}(t), \quad (2)$$

where  $P$  is pressure,  $E$  is elastance and  $V_S$  is stressed volume. Stressed volume is the part of actual volume that contributes to pressure.

The left ventricle is modelled using (Suga et al., 1973):

$$P_{lv}(t) = E_{lv} e(t) V_{S,lv}(t), \quad (3)$$

where  $E_{lv}$  is the maximum (end-systolic) elastance and  $e(t)$  is the normalised elastance, defined as:

$$e(t) = \exp \left[ -W \left( (t \bmod T) - \frac{T}{2} \right)^2 \right]. \quad (4)$$

In Equation 4,  $T$  represents the duration of a heartbeat and  $W$  is a parameter dictating the width of the Gaussian curve  $e(t)$ . Because of the modulo operator, the function  $e(t)$  is  $T$ -periodic. It ranges from nearly 0, during cardiac filling, to 1, at end-systole.

The three chambers are connected by vessel resistances representing the systemic circulation,  $R_c$ , the aortic valve,  $R_o$ , and the whole right circulation, from the tricuspid to the mitral valves,  $R_i$ . Flow,  $Q_c$ , through the systemic circulation is described by:

$$Q_c(t) = \frac{P_{ao}(t) - P_{vc}(t)}{R_c}. \quad (5)$$

The model assumes (i) that there is flow through the valves only if the pressure gradient is positive and (ii) that the flow through an open valve can also be described by Equation 5. Therefore:

$$Q_i(t) = \begin{cases} \frac{P_{vc}(t) - P_{lv}(t)}{R_i} & \text{if } P_{vc}(t) > P_{lv}(t) \\ 0 & \text{otherwise,} \end{cases} \quad (6)$$

$$Q_o(t) = \begin{cases} \frac{P_{lv}(t) - P_{ao}(t)}{R_o} & \text{if } P_{lv}(t) > P_{ao}(t) \\ 0 & \text{otherwise.} \end{cases} \quad (7)$$

Finally, the continuity equation gives the rate at which the volumes of the chambers change:

$$\dot{V}_{S,lv}(t) = Q_i(t) - Q_o(t), \quad (8)$$

$$\dot{V}_{S,ao}(t) = Q_o(t) - Q_c(t), \quad (9)$$

$$\dot{V}_{S,vc}(t) = Q_c(t) - Q_i(t). \quad (10)$$

Summing the previous equations gives:

$$\dot{V}_{S,lv}(t) + \dot{V}_{S,ao}(t) + \dot{V}_{S,vc}(t) = 0. \quad (11)$$

Consequently, the total stressed blood volume contained in the left ventricle, aorta and vena cava is a constant and a model parameter:

$$V_{S,lv}(t) + V_{S,ao}(t) + V_{S,vc}(t) = \text{SBV}. \quad (12)$$

Overall, the model has nine parameters: three elastances,  $E_{lv}$ ,  $E_{ao}$  and  $E_{vc}$ , three resistances,  $R_i$ ,  $R_o$  and  $R_c$ , the cardiac period,  $T$ , the width,  $W$ , and SBV. Parameter identification is used to compute the value of SBV and the other parameters from experimental data.

## 2.2 Experimental Data

To identify the model parameters, experimental animal data were used. These data were recorded during vascular filling experiments performed on two anaesthetised pigs, weighing 23.5 and 29 kg. The experiments were performed with the approval of the Ethics Commission for the Use of Animals at the University of Liège.

The pigs were first given a muscle relaxant, sedated and anaesthetised. The use of a muscle relaxant implied the need for mechanical ventilation, which was performed with a positive end-expiratory pressure of 5 cmH<sub>2</sub>O. The hearts of the animals were then accessed through a median sternotomy. Catheters (Transonic, NY) were positioned to provide continuous recording of:

- Left ventricular pressure,  $P_{lv}$ , and volume,  $V_{lv}$ ,
- Aortic pressure,  $P_{ao}$ ,
- Vena cava pressure,  $P_{vc}$ ,
- Flow through the proximal aorta,  $Q_{ao}$ .

A PiCCO monitor (Pulsion AG, Germany) was also used for pig 1, providing beat-to-beat recording of:

- Stroke volume, SV,
- Mean vena cava pressure,  $\bar{P}_{vc}$ ,
- Amplitude of the vena cava pressure,  $PP_{vc}$ .

The experimental procedure consisted in one first infusion of 500 ml saline solution over 30 minutes. Then, an endotoxin (lipopolysaccharide from *E. Coli*, 0.5 mg/kg) was infused over 30 minutes to induce a septic condition. After induction of septic condition, a second infusion of 500 ml saline solution was performed over 30 minutes. Twenty minutes later, a third infusion of 500 ml saline solution was performed, again over 30 minutes.

Since cardio-pulmonary interaction is not accounted for in the model, only data during temporary interruptions of the mechanical ventilation were used. The mechanical ventilator was paused for 20 s before each saline infusion and every time 100 ml of the 500 ml total saline solution had been infused. This procedure resulted in 15 pairs of data for each animal, 5 for each 500 ml fluid infusion. Only the last heartbeat of the 20 s interruption period was used for parameter identification, so that the haemodynamic signals were stabilised after the load change caused by pausing the ventilator.

## 2.3 Parameter Identification

The parameter identification procedure aims to reproduce the measured signals with the model. It involved four steps, described in the following four sections.

*I. Initial Parameter Values* To assign initial values to the model parameters, approximate formulae were used in combination with the available data (Pironet et al., 2015).

1. The cardiac period,  $T$ , was computed as the distance between two successive minima of the aortic pressure.
2. The initial value of the circulatory resistance was computed as (Klabunde and Dalley, 2004):

$$R_c \approx \frac{\bar{P}_{ao} - \bar{P}_{vc}}{\text{SV}} T, \quad (13)$$

where  $\bar{P}_{ao}$  is the mean aortic pressure.

3. Aortic elastance was estimated by fitting the following equation to aortic pressure during diastole:

$$P_{ao}(t) \approx \exp\left(-\frac{E_{ao}(t-t_{BD})}{R_c}\right) P_{ao}(t_{BD}). \quad (14)$$

where  $t_{BD}$  denotes the beginning of diastole.

4. Left ventricular end-systolic elastance was taken as:

$$E_{lv} \approx \max_T \frac{P_{lv}(t)}{V_{lv}(t)} \quad (15)$$

and minimum elastance was computed as:

$$E_{min} \approx \min_T \frac{P_{lv}(t)}{V_{lv}(t)}. \quad (16)$$

The normalised elastance was then obtained as:

$$e(t) \approx \frac{P_{lv}(t) - E_{min} V_{lv}(t)}{E_{lv} V_{lv}(t) - E_{min} V_{lv}(t)}. \quad (17)$$

Finally, the width parameter,  $W$ , was obtained by fitting Equation 4 to the previously computed curve.

5. Aortic valve resistance was initialised using:

$$R_o = \frac{\int_{P_{lv}(t) > P_{ao}(t)} (P_{lv}(t) - P_{ao}(t)) dt}{SV}. \quad (18)$$

6. The resistance of the right circulation was taken as:

$$R_i \approx \frac{\int_{P_{vc} > P_{lv}(t)} (\bar{P}_{vc} - P_{lv}(t)) dt}{SV}. \quad (19)$$

For pig 1, Equation 19 could not be used because measured  $\bar{P}_{vc}$  was always lower than measured  $P_{lv}(t)$ , which is physiologically possible, but inconsistent with the model. For this pig, initial  $R_i$  was set at

$$R_i = 0.05 \text{ mmHg s/ml}. \quad (20)$$

7. Venous elastance was estimated using:

$$E_{vc} \approx 2 \frac{PP_{vc}}{SV}. \quad (21)$$

8. To determine the initial value of SBV, the following equation was used:

$$SBV \approx \bar{V}_{lv} + \frac{\bar{P}_{ao}}{E_{ao}} + \frac{\bar{P}_{vc}}{E_{vc}}, \quad (22)$$

where  $\bar{V}_{lv}$  denotes the mean left ventricular volume over one cardiac period.

In the previous computations,  $T$ ,  $W$  and  $E_{lv}$  were computed by directly fitting the model to the data. Consequently, it was assumed that the parameter identification process would not largely alter these parameter values. They were thus excluded from the following sensitivity analysis procedure, and the remaining parameters were:

$$\mathbf{p} = (SBV \ E_{ao} \ E_{vc} \ R_c \ R_i \ R_o). \quad (23)$$

**II. Error Vector** Using the experimental data, the following indices were computed over one cardiac cycle:

- mean left ventricular volume,  $\bar{V}_{lv}$ ,
- left ventricular SV,  $SV_{lv}$ ,
- mean aortic,  $\bar{P}_{ao}$ , and vena cava pressures,  $\bar{P}_{vc}$ ,
- aortic,  $PP_{ao}$ , and vena cava,  $PP_{vc}$ , pulse pressures.

SV was computed as the height of the  $V_{lv}(t)$  curve and as the integral of the  $Q_{ao}(t)$  curve. For pig 1, the PiCCO provided additional measurements of SV,  $\bar{P}_{vc}$  and  $PP_{vc}$ . When several values were available for SV,  $\bar{P}_{vc}$  and  $PP_{vc}$ , they were averaged to provide the reference value.

The six beat-to-beat indices were grouped in an output vector:

$$\mathbf{y} = (\bar{V}_{lv} \ SV_{lv} \ \bar{P}_{ao} \ \bar{P}_{vc} \ PP_{ao} \ PP_{vc}). \quad (24)$$

The error vector  $\mathbf{e}$  was built as the relative error between simulated and measured values of the previous signals:

$$e_i = \frac{y_i^{mes} - y_i(\mathbf{p})}{y_i^{mes}}, \quad (25)$$

where  $y_i^{mes}$  are the measured values of  $\mathbf{y}$ , and  $y_i(\mathbf{p})$ , the simulated ones. Ventricular pressures were not included in the error vector since they had already been used to compute  $E_{lv}$  and  $W$ .

**III. Subset Selection Algorithm** A subset of the parameter vector  $\mathbf{p}$  was selected for optimization using a dedicated algorithm, introduced by Burth et al. (1999). This algorithm performs a sensitivity analysis on the error vector  $\mathbf{e}$  and selects the  $\rho$  parameters to which  $\mathbf{e}$  is the most sensitive. In this work  $\rho$  was selected as the  $i$  ( $> 1$ ) that maximised the ratio of two successive eigenvalues of the Hessian matrix  $h_i/h_{i+1}$ , when they were sorted in decreasing order, *i.e.*  $h_i \geq h_{i+1}$ . Applying this method,  $\rho$  was found to be equal to 5 for all 30 datasets, and the rejected parameter systematically was  $R_o$ .

**IV. Iterative Identification of the Selected Parameters**

The 5 selected parameters were computed by an iterative procedure. The objective of this procedure was to minimise the sum of squared errors (SSE):

$$SSE = e_1^2 + e_2^2 + e_3^2 + e_4^2 + e_5^2 + e_6^2. \quad (26)$$

This task was performed using the simplex method for nonlinear optimisation combined with a custom implementation of the proportional method of Hann et al. (2010). The initial values needed by this algorithm were the ones computed in step I. All computations were performed using Matlab (2015b, MathWorks, Natick, MA).

## 3. RESULTS

### 3.1 Haemodynamic Effects of Endotoxin Infusion

Figure 2 shows the evolution of the experimentally measured mean aortic pressure,  $\bar{P}_{ao}$ , during the whole experiment. Figure 3 shows the evolution of the the initial value of the resistance  $R_c$ , given by Equation 13, which corresponds to the medical definition of systemic vascular resistance (Klabunde and Dalley, 2004).

### 3.2 Quality of the Parameter Identification

After parameter identification on the 30 datasets, the SSE amounts to 0.0339 on average and ranges from 0.0002 to 0.214. The quality of the parameter identification is thus very good, which also implies that the very simple 3-chamber CVS model used can capture the diversity of the experimental measurements obtained, both in the basal state and after endotoxin infusion.

A representative example of parameter identification is displayed in Figure 4. The SSE for the corresponding dataset is 0.0317. Simulated and measured pressures and volumes are thus in good agreement.

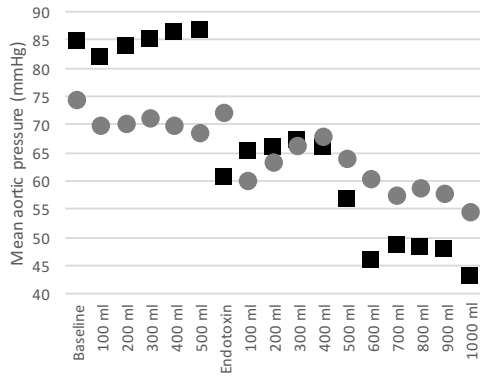

Fig. 2. Evolution of mean aortic pressure during the whole experiment for pigs 1 (squares) and 2 (circles)

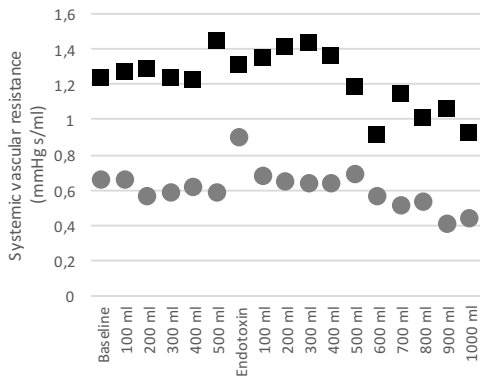

Fig. 3. Evolution of systemic vascular resistance during the whole experiment for pigs 1 (squares) and 2 (circles)

### 3.3 Relation Between SBV and Relative Change in CO

Table 1 shows the relative change in CO ( $\Delta\text{CO}$ ) that resulted from each fluid infusion step. Table 1 also shows the identified value of SBV before each fluid infusion. The correlation coefficient between SBV and  $\Delta\text{CO}$  is equal to  $-0.15$  for pig 1 and  $-0.92$  for pig 2.

Table 1. Summary of the experimental outcomes.

Dataset	Infused volume	$\Delta\text{CO}$	SBV
Pig 1 baseline	500 ml	$-14.6\%$	175.7 ml
Pig 1 endotoxin	500 ml	$20.9\%$	144.4 ml
Pig 1 endotoxin	500 ml	$-18.6\%$	131.7 ml
Pig 2 baseline	500 ml	$4.7\%$	1087.6 ml
Pig 2 endotoxin	500 ml	$10.4\%$	861.8 ml
Pig 2 endotoxin	500 ml	$29.7\%$	697.5 ml
Average	500 ml	$5.4\%$	

To investigate why the strength of the relation is so different for the two animals, Figure 5 displays the evolution of SBV and  $\Delta\text{CO}$  every 100 ml of fluid infused, for the three 500 ml fluid infusion steps performed on the 2 animals. Overall, Table 1 and Figure 5 show that, the higher the SBV, the lower the  $\Delta\text{CO}$ .

Negative correlations are also present SBV and  $\Delta\text{SV}$  (not shown). The correlation coefficient ranges from  $-0.33$  to and  $-0.81$ . This difference is partly caused by the fact that the heart rate was not constant during the fluid infusions.

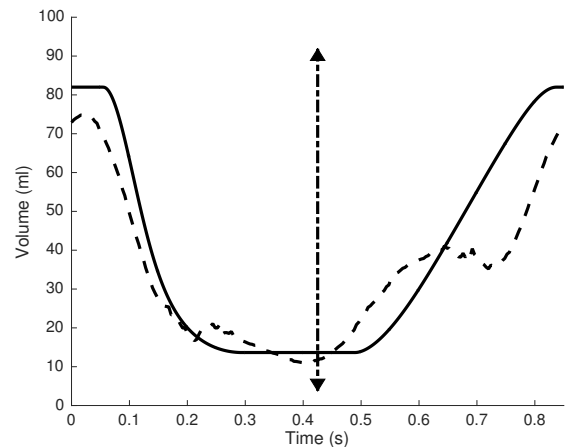
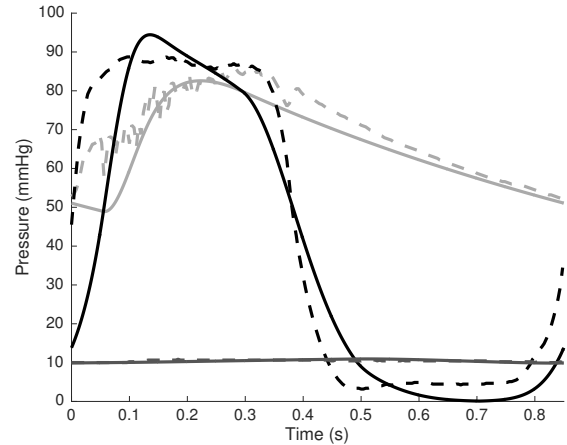

Fig. 4. Identification result for pig 2, after 100 ml fluid infusion and before endotoxin. *Top*: simulated (full lines) and measured (dashed lines) left ventricular (black), aortic (light grey) and vena cava (dark grey) pressures. *Bottom*: simulated (full line) and measured (dashed line) left ventricular volumes. The arrow represents SV computed as the integral of measured aortic flow.

## 4. DISCUSSION

This work aimed to investigate the value of the model-based index SBV for prediction of fluid responsiveness in two cases of septic shock caused by endotoxin infusion. As shown in Figures 2 and 3, the endotoxin infusion caused an expected drop of mean aortic pressure and systemic vascular resistance. The endotoxin-induced hypotension was not solved by the two subsequent filling phases, which corresponds to some definitions of septic shock (Gupta et al., 2015). Hypotension in septic shock is thought to be caused by peripheral vasodilation, which correlates with the drop in systemic vascular resistance observed in Figure 3.

Fluid resuscitation is the first choice intervention in the treatment of septic shock. However, it is not always efficient in increasing CO, as shown in Table 1, where two out of six fluid infusions resulted in negative changes in measured CO. Using  $\Delta\text{CO} > 12\%$  as a threshold for fluid responsiveness (Maas et al., 2012), two out of six infusions were associated with a positive response. This

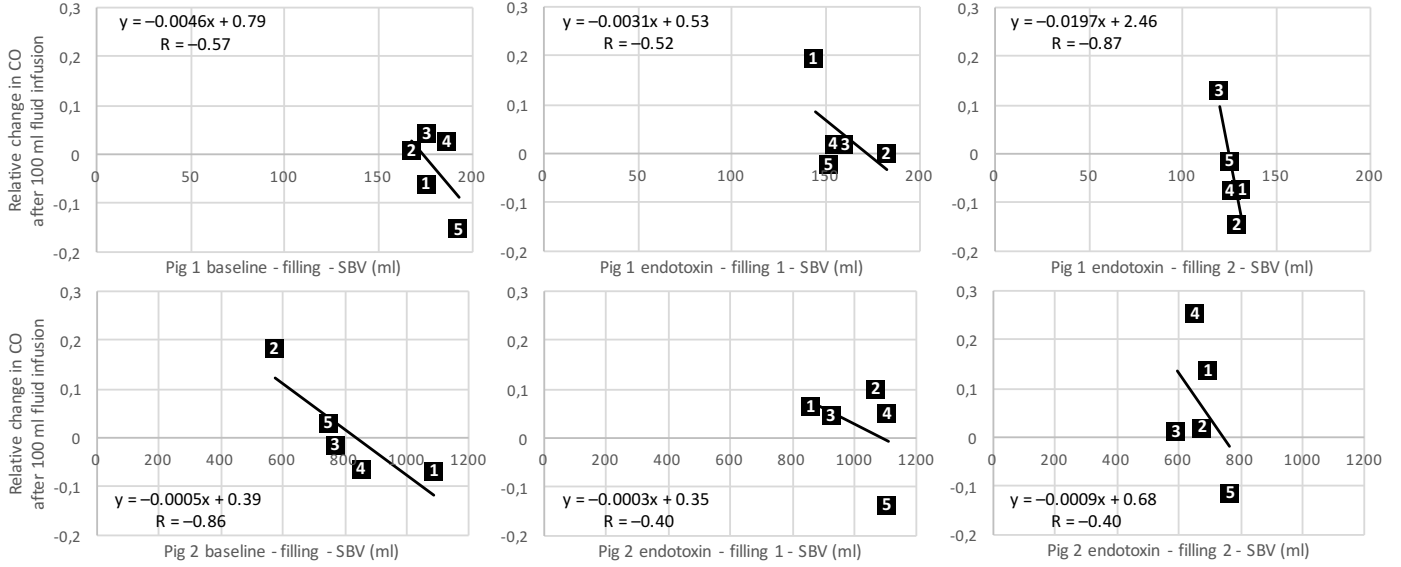

Fig. 5. Relative change in CO after each 100 ml fluid infusion plotted versus the identified SBV value before infusion. The numbers in the squares indicate the sequence of fluid administrations.

rate is similar to the usual 50 % typically reported for ICU patients (Maas et al., 2012). Furthermore, fluid infusion can even be harmful in certain cases. For these reasons, clinicians are looking for ways to predict the effect of fluid resuscitation.

#### 4.1 Relation Between SBV and Relative Change in CO

The available data allowed identification of the model parameters, including SBV, which represents the total stressed blood volume in the model. As shown in Table 1, SBV is negatively associated with the  $\Delta CO$  following fluid infusion. Such a relationship was theoretically expected, since SBV represents the pressure-generating volume in the CVS. If this volume is already high, a fluid infusion might not be beneficial.

A negative correlation between SBV and  $\Delta CO$  after fluid infusion was previously observed by Maas et al. (2012) in humans. However, the method they used to compute SBV required several fluid infusions, which meant that SBV could not be used as a predictive index of fluid responsiveness.

Conversely to the method of Maas et al. (2012), the model-based method to estimate SBV presented in this work does not require fluid infusions. Using the model-based method, Pironet et al. (2015) also observed a negative correlation between SBV and  $\Delta CO$  after fluid administration in 8 healthy pigs. The correlation coefficients ranged from  $-0.38$  to  $-0.92$ .

In this work, the correlation coefficients between SBV and  $\Delta CO$  were very different, being equal to  $-0.15$  for pig 1 and  $-0.92$  for pig 2. Figure 5 shows that the relation between SBV and  $\Delta CO$  during one fluid infusion is strongly affected by endotoxin. The slope of the relation between SBV and  $\Delta CO$  seems to be first decreased by endotoxin infusion, but increases towards the end of the experiment. These observations explain the weaker correlations observed for septic pigs than for healthy pigs.

This influence of endotoxin on the slope of the relation between SBV and  $\Delta CO$  could be confirmed using a wider sample of animal data. Using new datasets is expected to provide negative slopes in all cases, as observed in this study and previous ones.

#### 4.2 An Algorithm to Guide Fluid Infusion

Because the relation between SBV and  $\Delta CO$  is different from one fluid infusion to the other, using SBV to predict fluid responsiveness requires some sort of calibration step. This calibration step could consist in a first 100 ml fluid infusion. Then, according to the SBV values before and after the infusion, and the resulting  $\Delta CO$ , one or several further infusions could be recommended, as dictated by the algorithm presented in Figure 6.

Retrospectively using the algorithm of Figure 6 on the experimental data results in the outcomes presented in Table 2. These outcomes are computed under the assumption that  $\Delta CO$  remains at its current value when fluid infusion is stopped. The resulting average  $\Delta CO$  is very similar to the experimental one, but is achieved with 60 % less fluid, which is a significant improvement.

Table 2. Summary of the experimental outcomes if the algorithm of Figure 6 had been applied. The ranges provided in the table are caused by the two possible strategies when the algorithm makes no recommendation.

Dataset	Infused volume	$\Delta CO$
Pig 1 baseline	100 ml	$-5.6$ %
Pig 1 endotoxin	100 ml	$19.2$ %
Pig 1 endotoxin	200 to 300 ml	$-8.7$ to $-21.6$ %
Pig 2 baseline	200 ml	$11.4$ %
Pig 2 endotoxin	100 ml	$6.5$ %
Pig 2 endotoxin	200 to 500 ml	$15.2$ to $41.8$ %
Average	200 ml	$5.2$ %

The algorithm of Figure 6 requires an initial 100 ml fluid infusion to provide a first recommendation. The idea of

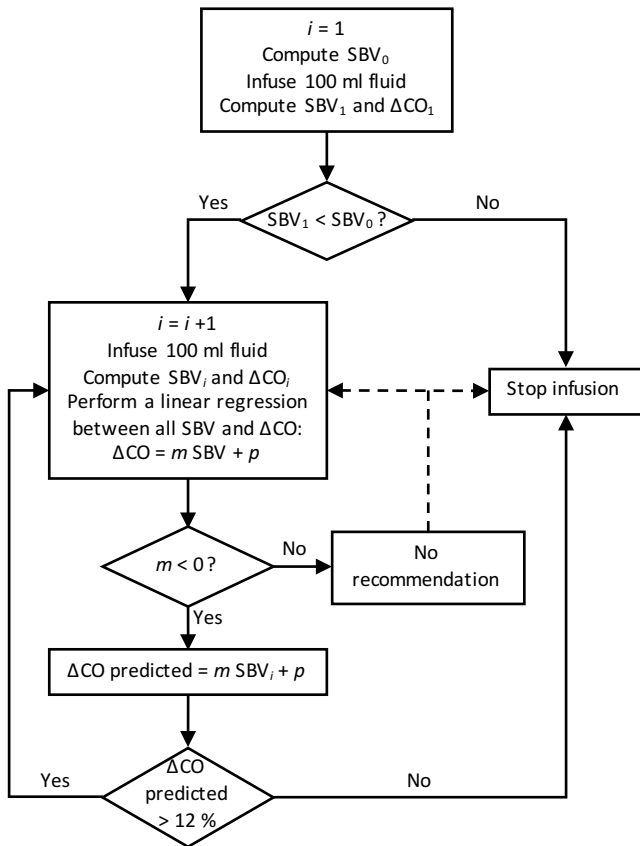

Fig. 6. Decision-support algorithm to guide fluid resuscitation. When the slope  $m$  of the linear regression is positive, the prediction is potentially wrong. The algorithm thus makes no recommendation in this case, leaving the decision to infuse to the clinician.

performing a "mini-fluid challenge" to decide whether to infuse more fluid has previously been proposed by Muller et al. (2011). According to these authors, a  $\Delta\text{CO} \geq 10\%$  after an initial 100 ml fluid infusion is a good predictor of a  $\Delta\text{CO} \geq 15\%$  after 500 ml fluid infusion. As can be deduced by comparing Table 1 and Figure 5, this effect is not present here.

#### 4.3 Applicability in the ICU

This work uses a very simple model of the CVS, representing the left ventricle, an arterial compartment, and a venous compartment. The eight parameters of this model are identified using clinically available data: mean left ventricular volume, stroke volume, arterial pressure and venous pressure. Such data can be obtained using the recommended tools for monitoring of septic shock (Cecconi et al., 2014). In particular, mean left ventricular volume can be estimated using echocardiography.

The experimental measurements used in this work also include left ventricular pressure and volume, which are not routinely measured in the ICU. However, these measurements are only used to obtain some of the initial parameter values. In the ICU, other methods, such as the use of constant population values, would need to be used. Starting from these initial values, the parameter identification is performed using only the vector  $\mathbf{e}$ , which contains data available in the ICU.

## 5. CONCLUSION

SBV is an important parameter of a simple mathematical model of the CVS. This parameter was previously shown to be an index of fluid responsiveness in healthy pigs. In this work, the method to compute SBV was applied to data from pigs infected by endotoxin, to simulate the effects of septic shock.

The computed SBV value presented a negative association with the  $\Delta\text{CO}$  after fluid infusions, as expected theoretically and from the results of previous studies. A decision-support algorithm is presented based on this parameter. The algorithm can potentially be applied during human clinical trials, since the data required for parameter identification can be obtained in an ICU.

## REFERENCES

- Burth, M., Verghese, G.C., and Velez-Reyes, M. (1999). Subset selection for improved parameter estimation in on-line identification of a synchronous generator. *IEEE Transactions on Power Systems*, 14(1), 218–225.
- Cecconi, M., De Backer, D., Antonelli, M., Beale, R., Bakker, J., Hofer, C., Jaeschke, R., Mebazaa, A., Pinsky, M.R., Teboul, J.L., Vincent, J.L., and Rhodes, A. (2014). Consensus on circulatory shock and hemodynamic monitoring. task force of the european society of intensive care medicine. *Intensive Care Medicine*, 40(12), 1795–1815.
- Gupta, R., Hartigan, S., Kashiouris, M., Sessler, C., and Bearman, G. (2015). Early goal-directed resuscitation of patients with septic shock: current evidence and future directions. *Critical Care*, 19(1), 286.
- Hann, C., Chase, J.G., Desai, T., Froissart, C.B., Revie, J.A., Stevenson, D.J., Lambermont, B., Ghuysen, A., Kolh, P., and Shaw, G.M. (2010). Unique parameter identification for cardiac diagnosis in critical care using minimal data sets. *Computer Methods and Programs in Biomedicine*.
- Klabunde, R. and Dalley, A. (2004). *Cardiovascular physiology concepts*. Lippincott Williams & Wilkins.
- Maas, J.J., Pinsky, M.R., Aarts, L.P., and Jansen, J.R. (2012). Bedside assessment of total systemic vascular compliance, stressed volume, and cardiac function curves in intensive care unit patients. *Anesthesia & Analgesia*, 115(4), 880–887.
- Muller, L., Toumi, M., Bousquet, P.J., Riu-Poulenc, B., Louart, G., Candela, D., Zoric, L., Suehs, C., de La Coussaye, J.E., Molinari, N., Lefrant, J.Y., and Group, A. (2011). An increase in aortic blood flow after an infusion of 100 ml colloid over 1 minute can predict fluid responsiveness: the mini-fluid challenge study. *Anesthesiology*, 115(3), 541–7.
- Pironet, A., Dauby, P.C., Chase, J.G., Kamoi, S., Janssen, N., Morimont, P., Lambermont, B., and Desai, T. (2015). Model-based stressed blood volume is an index of fluid responsiveness. *IFAC-PapersOnLine*, 48(20), 291–296.
- Suga, H., Sagawa, K., and Shoukas, A.A. (1973). Load independence of the instantaneous pressure-volume ratio of the canine left ventricle and effects of epinephrine and heart rate on the ratio. *Circulation Research*, 32(3), 314–322.