

Energy, grids and microgrids.

Prof. Damien ERNST

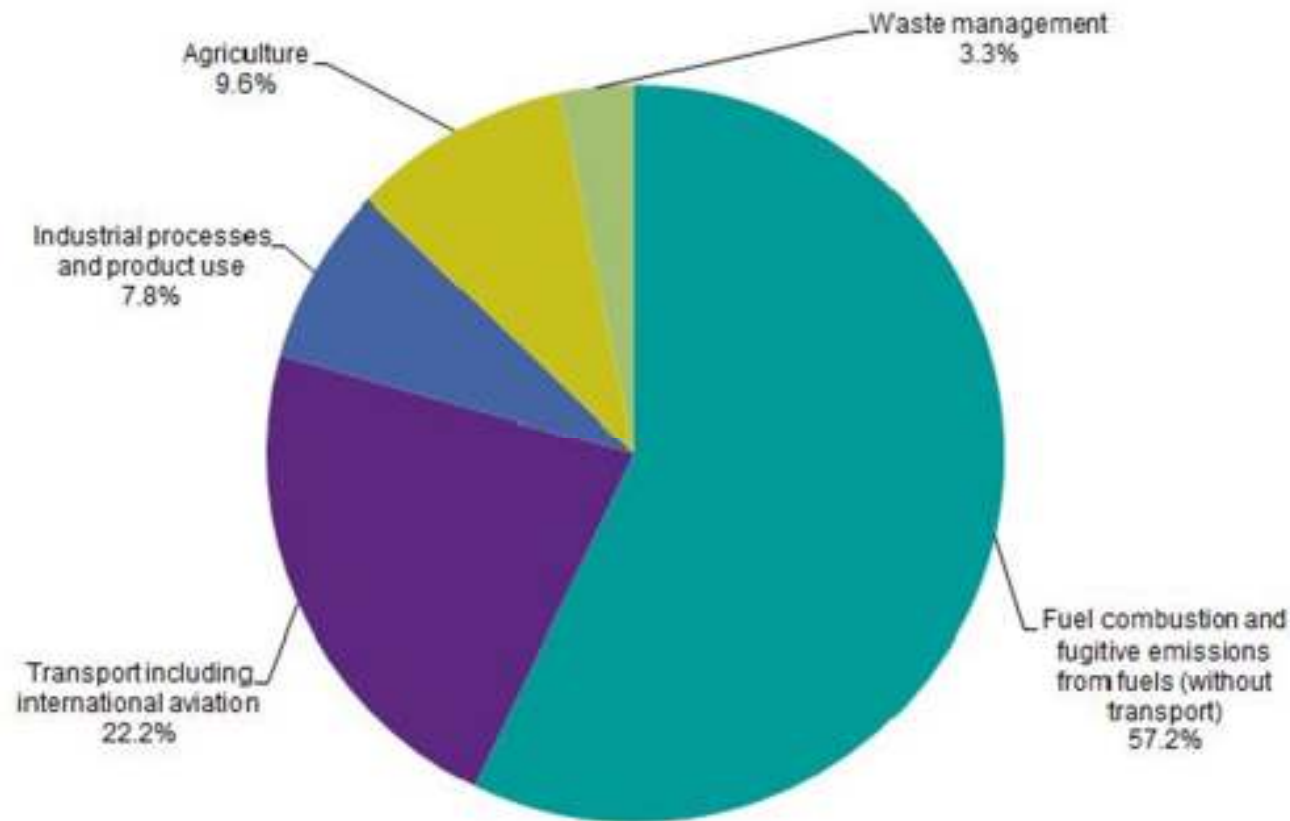

Greenhouse gas emissions, by source sector, EU-28, 2013 (% of total):



COP21: Ambitious cuts in greenhouse gas emissions => Necessarily implies (virtually) stopping burning fossil fuels.

Three credible alternatives?

Nuclear power. Costs in 2016: 60€/MWh-120€/MWh. Depend on the technology used, the regulation and the labour costs.

Wind energy. Cost in 2016: 40 €/MWh-140€/MWh. On-shore energy generation is less expensive than off-shore generation, but there are a limited number of suitable places for installing wind turbines on land. Costs are dropping.

Solar energy. Cost in 2016: 26 €/MWh-130€/MWh. Strong dependance on solar irradiance. Costs dropping **rapidly**.

Low Solar Bids (2013–2016)

Prices agreed to under 20- and 25-year power purchase agreements. Note that the low bids in Texas are actually lower than the amounts represented in the chart... but exact figures have not been revealed.

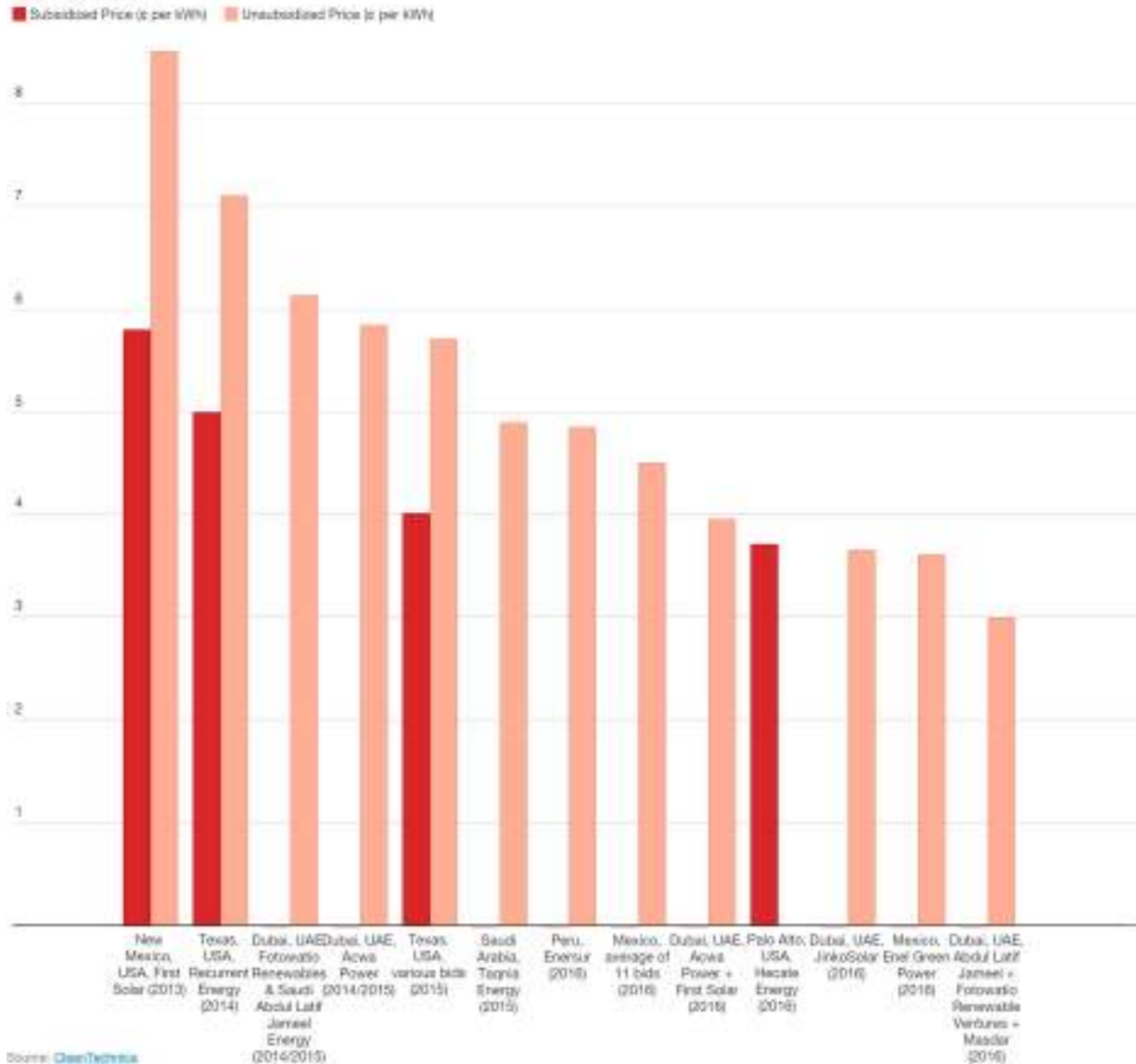

Credible perhaps, challenging certainly

Let us assume that the average final energy consumption in Belgium is around 150 kWh/person/day. There are around 11 million people living in Belgium. Yearly energy consumption Belgium : $150 \times 365 \times 11 \times 10^6 \simeq$ **600 TWh**. This is equivalent to the yearly energy generated by a source having a constant power output of 68,493 MW.

Official statistics for final energy consumption: 44.028 MTOe = **512 TWh**. Actual final energy consumption greater than in official statistics that do not take into account energy embodied into the stuff we import from abroad.

Electricity consumption in Belgium in 2013: **83 TWh**, that is around **8 times less** than the total energy consumption of the country => It is naive to think that the Belgian electrical grid could easily be adapted to transport 600 TWh of electrical energy every year, or even 150 TWh every year.

How to generate 600 TWh of energy every year ?

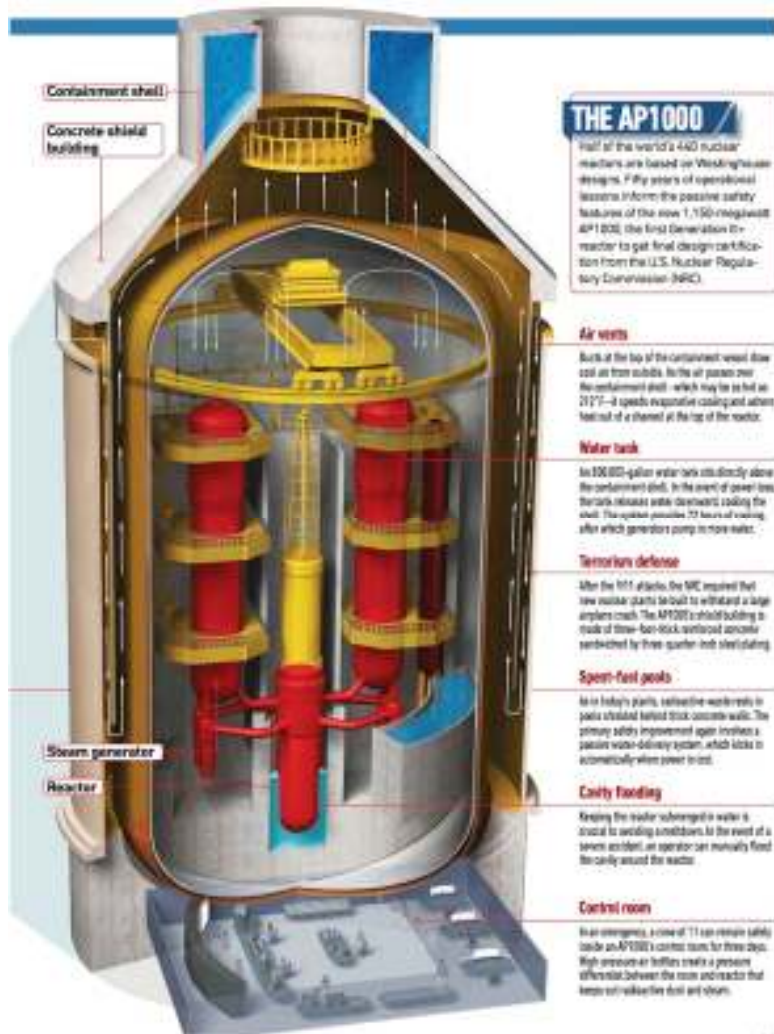

69 AP1000 nuclear reactors (designed and sold by Westinghouse Electric). That corresponds to 76103 MW of installed nuclear power capacity, or 12.7 times the nuclear power capacity available in Belgium in 2016.

Data: Peak power of an AP1000 = 1100 MW, load factor = 90%, installed nuclear power in Belgium in 2016 = 6000 MW.



3424 km² of PV panels. This corresponds to an installed capacity of 685 GW (1 GW = 10⁹ W), or around 200 times the installed PV capacity in Belgium in 2016.

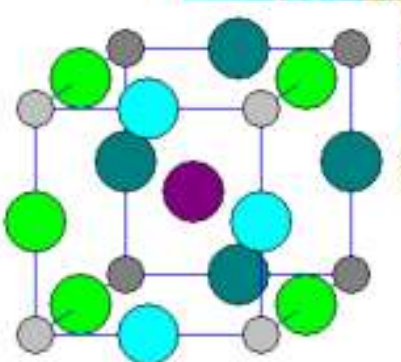
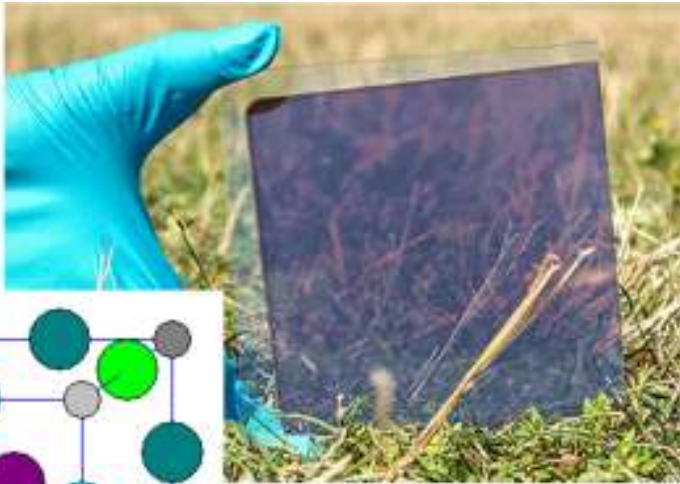

Perovskite CaTiO₃

Data: Solar irradiance = 100 W/m². Efficiency of PV panels 20%. Load factor of PV panels: 10%. Installed PV capacity in Belgium in 2016: around 3 GW.



30220 Enercon-126 wind turbines = 229,071 MW of installed wind capacity, around 100 times more than the wind capacity currently operational in Belgium in 2016. This would correspond to wind farms covering 17,180 km² of land.

Data: Maximum power of an Enercon-126 wind turbine = 7.58 MW, load factor= 30%. A wind farm can collect around 4 W/m² in Belgium. Wind capacity in Belgium in 2016: around 2000 MW.

What about storage needs?

Power Produced = Power Consumed + Power Stored + Power Wasted

Storage needs for daily fluctuations : We compute the storage needs caused by daily fluctuations of PV installations in Belgium by assuming that all the energy (600 TWh/year or 150 kWh/person/day) is generated by PV panels. We make the following assumptions: (i) the load will be constant (ii) PV sources generate a constant power from 7 am till 7 pm and no power outside those hours. (iii) Efficiency of 1 for storage.

Storage capacity needed: $600 \div 365 \div 2 = 0.82$ TWh = 820,000,000 kWh

The Tesla Powerwall: capacity of 7 kWh and price tag of around €3000 => 117,142,857 Powerwalls would be needed. It would cost **€351 billion**. With rapid progresses in battery technology, this amount is likely to drop to **less than €100 billion** by 2020.

Note that with a price tag of around €1/Wp for the PV panels, installing the PV capacity necessary for producing 600 TWh of energy per year in Belgium would cost **€685 billion**.

Note: GDP Belgium in 2015 : **€400 billion**





Average solar irradiance figures (in kWh/day/m²) in Belgium



Jan	Feb	Mar	Apr	May	Jun	Jul	Aug	Sep	Oct	Nov	Dec
0.9	1.5	2.5	3.7	4.8	5.0	4.9	4.3	2.9	1.8	1.0	0.7

Storage needs for daily fluctuations: Solar irradiance during the six sunniest months of the year (April –September) is three times higher than during the other months of the year (October-March). To smooth out the seasonal fluctuations of PV energy, a quarter of the 600 TWh would have to be stored during the sunny period, that's 150 TWh. This would cost **thousands of billions** of euros for storing this energy with batteries.

Other solutions: (i) Oversize the PV installations and throw power away during the sunny period (ii) Transform electricity into hydrogen that has a storage cost of around €2/kWh (and probably around €100/kWh for batteries in 2020). **There is the possibility of using this hydrogen directly as a substitute for carbon-based fuels.**

Producing huge amounts of renewable energy: challenges ahead for distribution networks

Storage, smart management of the system and investments in cables and lines: required for **integrating** significant amount of renewable energy into distribution networks.

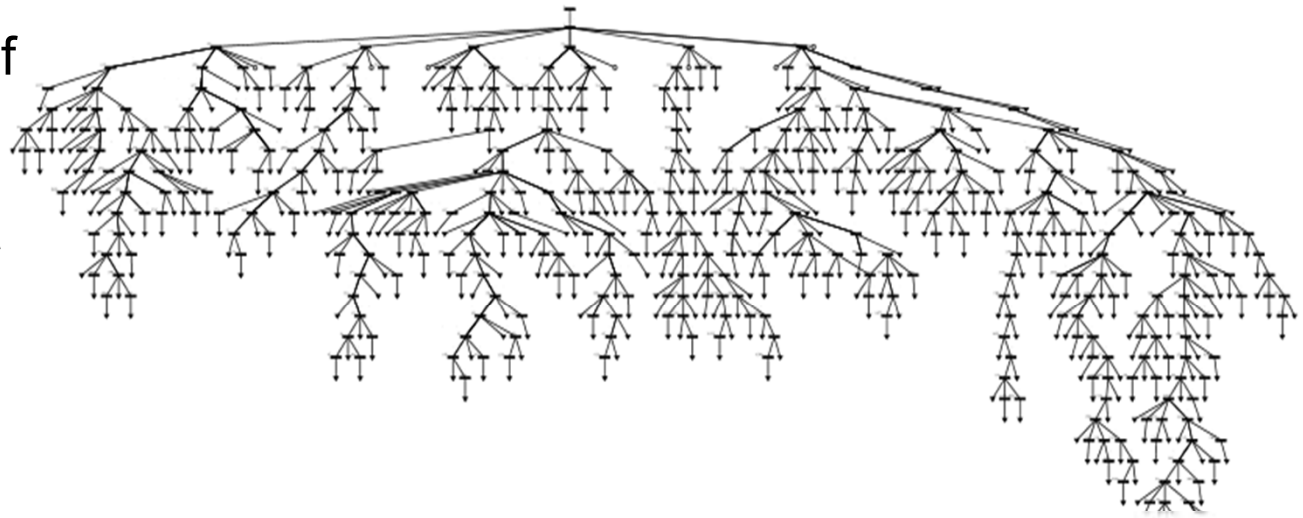

Microgrids are also a key part of the solution.

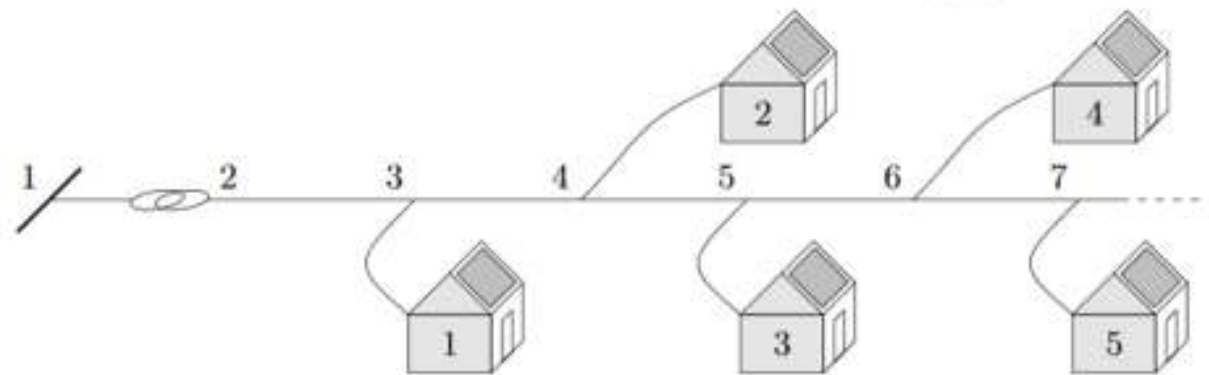



A **microgrid** is an electrical system that includes single or multiple loads as well as one or several distributed energy sources that can be operated in parallel with the broader utility grid.

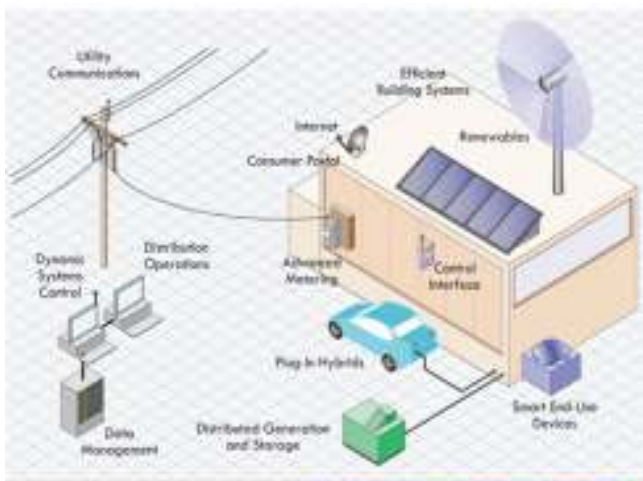

CAPABILITIES OF A SMART MICROGRID
 This revolutionary system design meets U.S. energy challenges and provides consumer and business value.

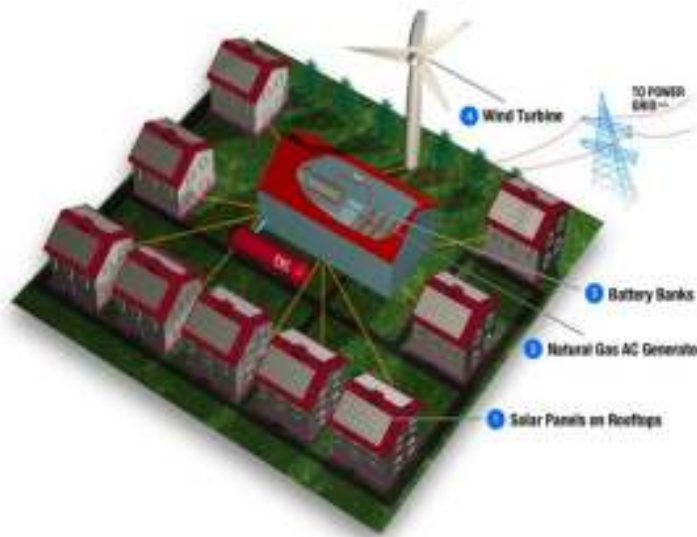

A global problem and a global grid as a solution?

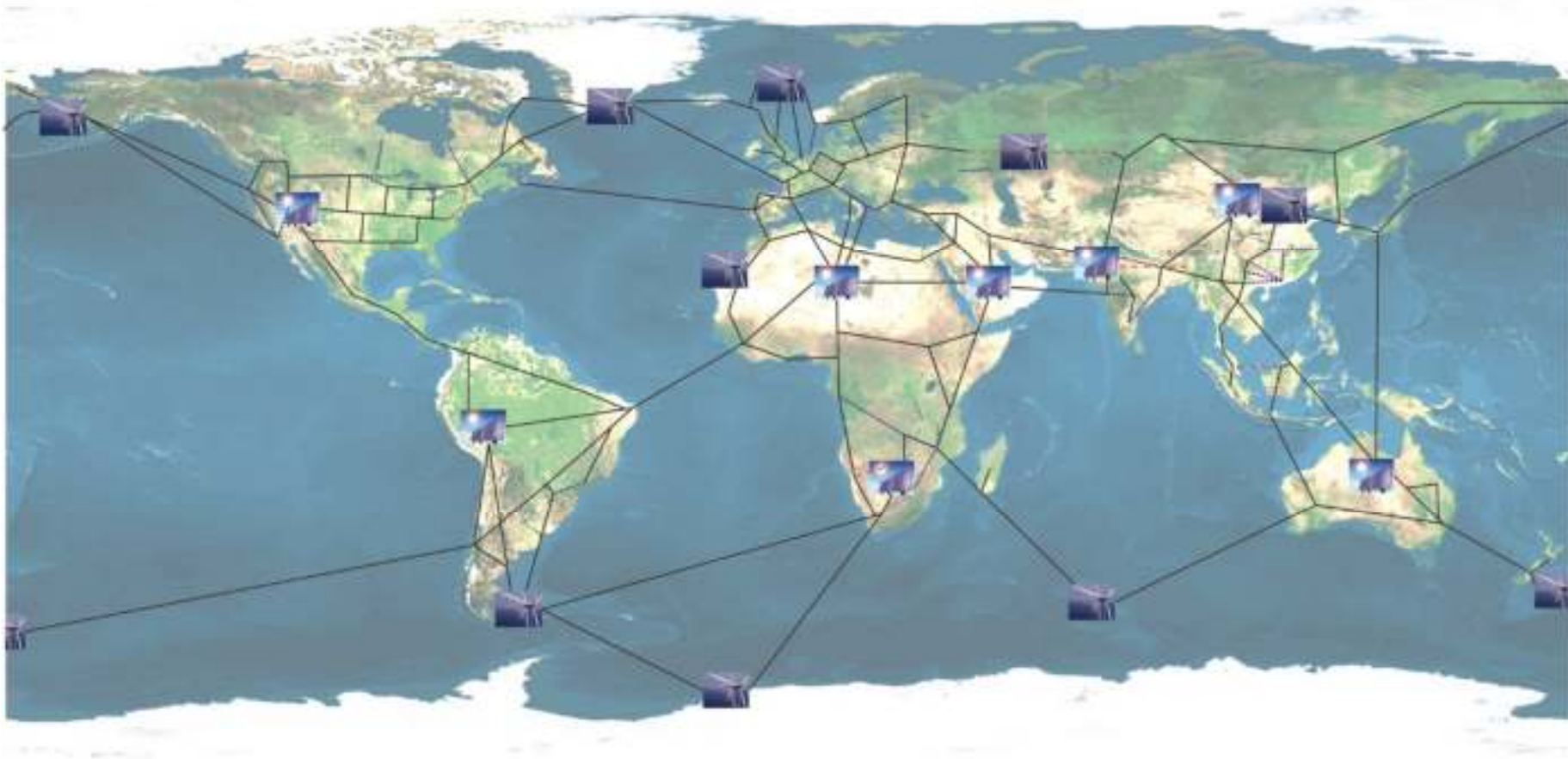

More at: <http://blogs.ulg.ac.be/damien-ernst/tedx-talk-the-global-grid-for-empowering-renewable-energy/>

Why a global supergrid?

- 1.** In many countries, you have only a limited number of prime locations for harvesting renewable energy
- 2.** Intermittency of renewable energy sources
- 3.** Tapping into rich veins of renewable energy sources

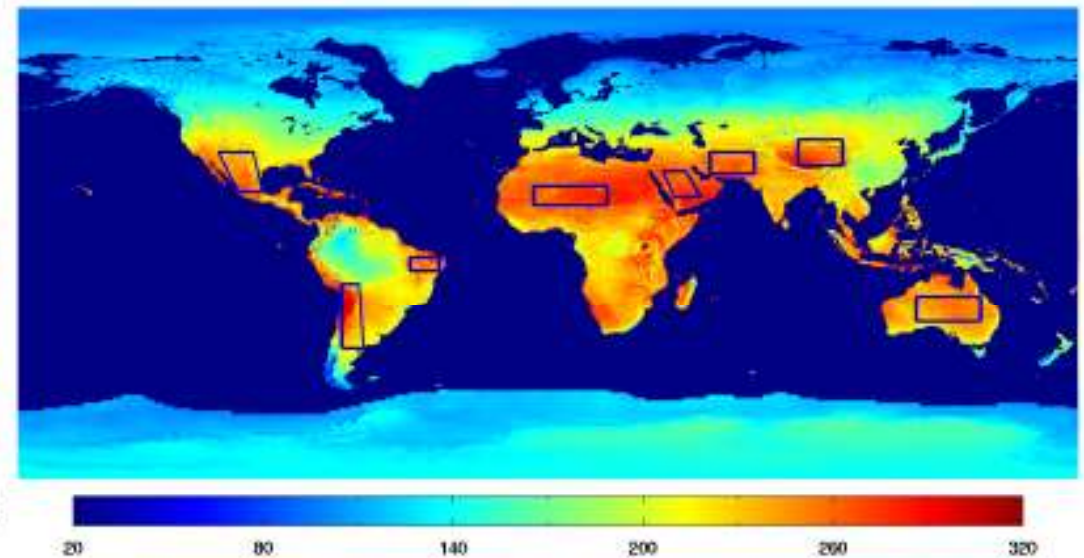
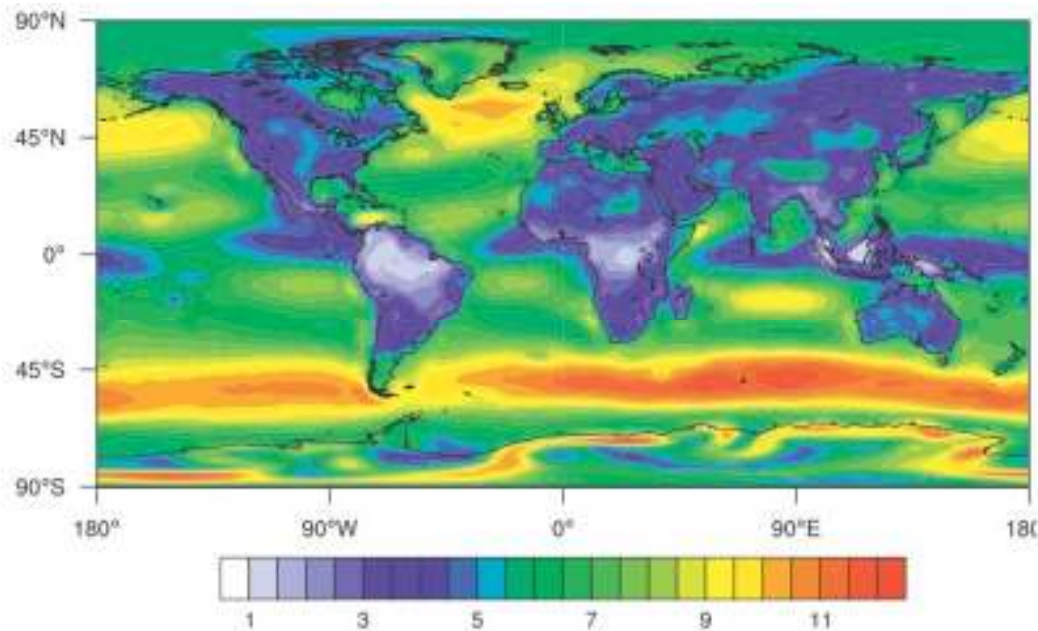

China proposes \$50tn global renewable energy network

Published time: 1 Apr, 2016 14:34

[Get short URL](#)



A worker inspects solar panels at a solar farm in Dunhuang, 950km (590 miles) northwest of Lanzhou, Gansu Province. © Carlos Barria / Reuters



The company running China's power grid is proposing a \$50 trillion global electricity network to tackle pollution and climate change. If it goes ahead the network would use advanced renewable solar and wind technology and be operating by 2050.

The electrical grid as it used to be

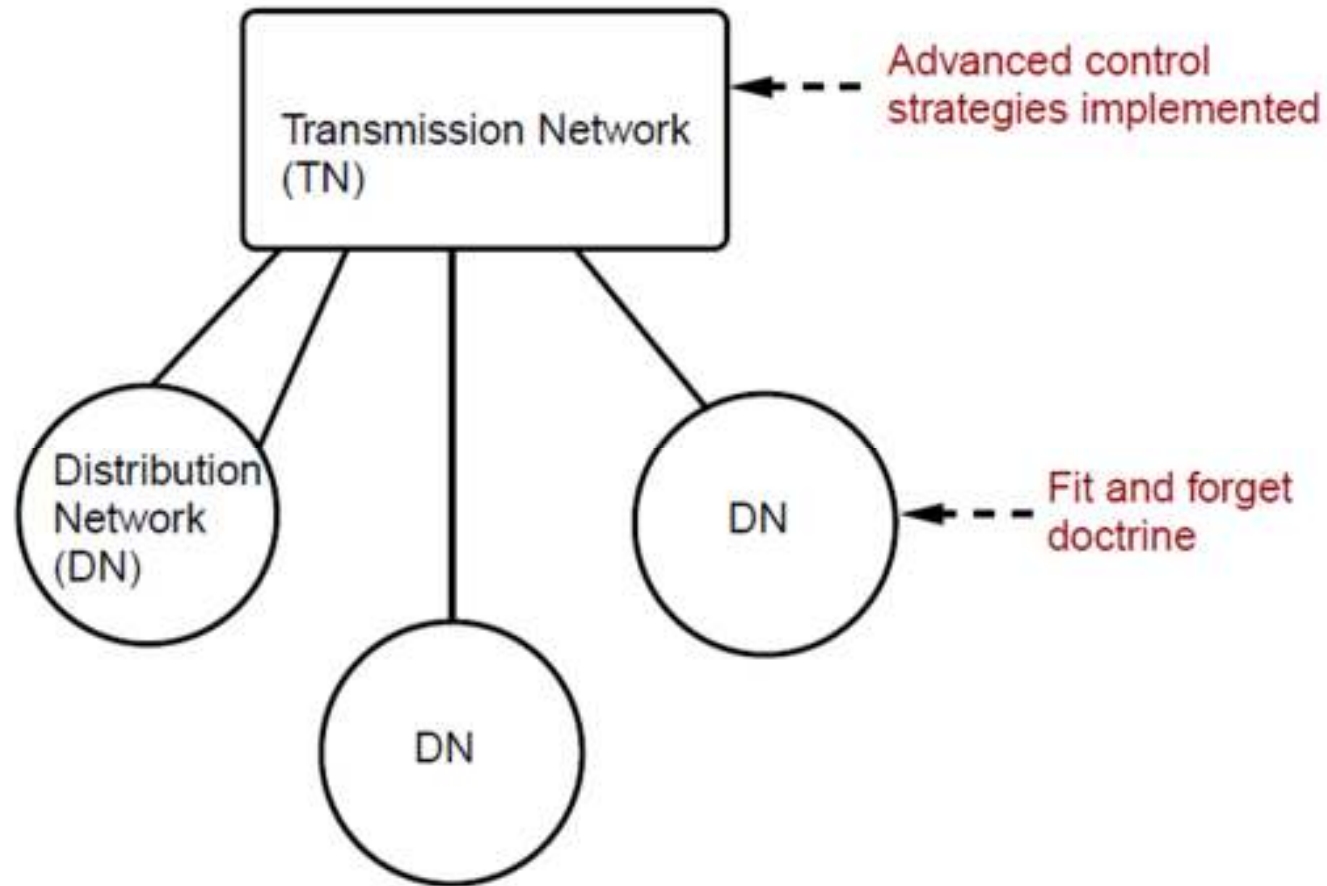

The future electrical grid

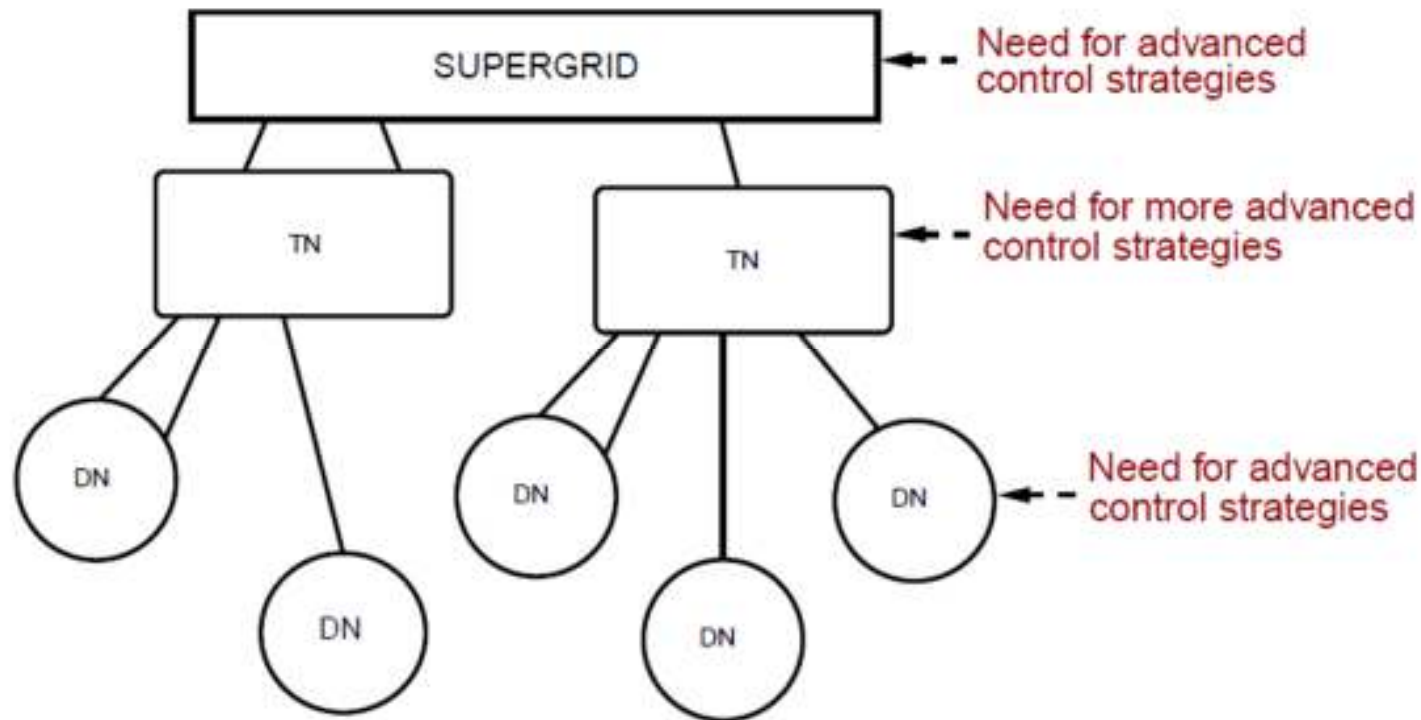

Challenges for designing top-performing control strategies and making them work together are **immense**, especially in a deregulated (market) environment. Microgrids (and other alternative models) may help to make things **much simpler**.

Governments and distribution grids versus microgrids

With current regulation microgrids highly competitive in Belgium (e.g., retail price for electricity at 400 V: 300 €/MWh; domestic PV < 100 €/MWh).

Network companies and governments will observe a drop in revenue with the rise of microgrids.

This is likely to see the introduction of less favorable regulations for microgrids in the years to come.

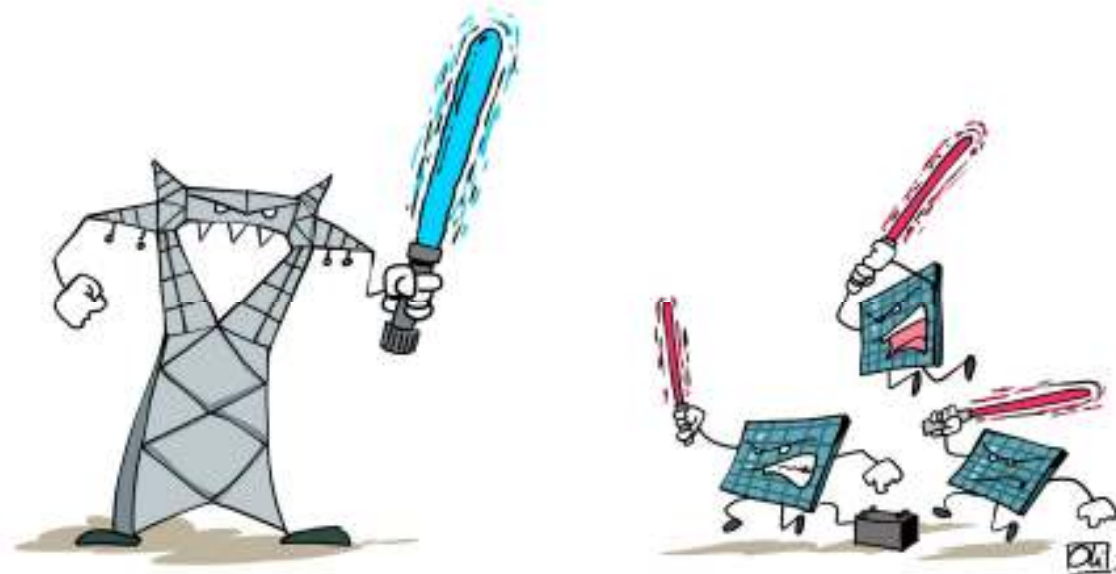

This Is What the Utility Death Spiral Looks Like



In Germany, utility revenues are spiraling down the rabbit hole. Will American power companies follow?

by Stephen Lacey
March 04, 2014

Will Solar Cause A 'Death Spiral' For Utilities?



Energy Source
Voices from the world of energy.

[FULL BIO >](#)



Christopher Helman,
Forbes Staff

By **Jean-Marc Ollagnier, Accenture**

Solar panels are sprouting up fast and getting cheaper everyday. Soon some of the homes and businesses that own or lease these solar systems could "cut the cord" and unplug entirely from the power grids operated by their regional power utilities. But let's start by dispelling a myth. What has popularly become known in the industry as the utilities "death spiral" is extremely unlikely to occur. Distributed generation like solar will



The Utility Death Spiral Scenario Is Realistic

May 27, 2015 3:47 PM ET | Includes: EIX, PCG, PEG, PNW, SO



Simple Investment Ideas @ Follow (1,675 followers)
Long/short equity, value, growth, growth at reasonable price
[Send Message](#)

Summary

- The centralized electric utilities are doing everything in impede the growth of decentralized energy generation, should only accelerate the utilities' eventual collapse.



In Hawaii, rooftop solar panels threaten 'utility death spiral'

Microgrids sneaking past (adversarial) regulation

PV energy injected into the network is paid only at the wholesale market price?

Install batteries to boost local consumption of your electricity.

Network tariff based on peak demand? Use batteries to do peak shaving.



High fixed network charges? Go fully off-grid with batteries for smoothing out short-term fluctuations and a diesel generator for long term ones or your EV car working in a EV to microgrid mode.



Direct taxes on microgrids? Well, with this scenario, there is not much you can do.



Why our governments should to support microgrids?

1. Microgrids mean local economic activities. Installing/building microgrids will create a lot of local jobs. There is also an opportunity to grow a microgrid-related industry that would export products all over the world. Countries rapidly choosing to support microgrids will be best placed for exploiting it (as Denmark did with wind power).

2. An electrical power system with a high-penetration rate of microgrids is a structure which is resilient to terrorist/cyber attacks, technological failures, a global short-age of supply or disastrous meteorological conditions.

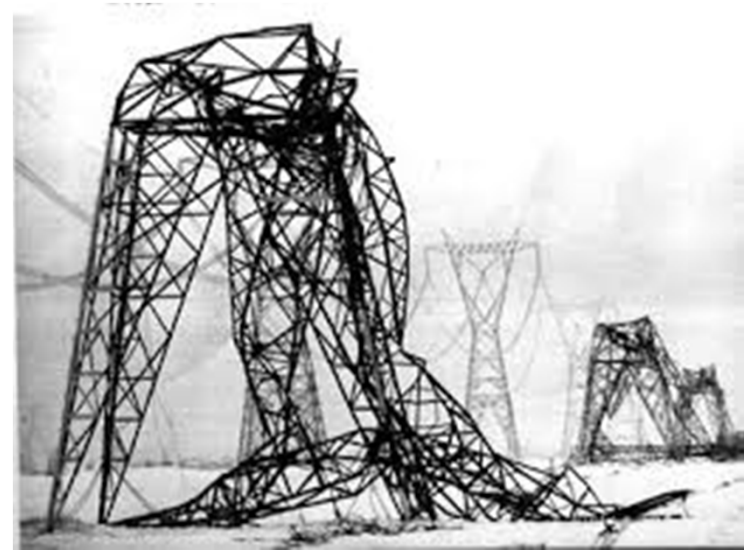

3. With microgrids, electrical power production can **belong to the people and small companies** as for consequences: increased security of supply, better control over prices, increased middle-class welfare, better competitiveness for companies.



4. Much better for Wallonia to “subsidize” PV energy and battery in microgrids that to pay for off-shore wind.



Damien Ernst et Michel Hermans
Professeurs à l'Université de Liège

19/02/16 à 13:51 - Mise à jour à 13:50

Mer ou RER : faut-il vraiment 10 milliards d'argent public pour l'éolien offshore?

Marie-Christine Marghem, une vraie écologiste en charge de l'énergie, de l'environnement et du développement durable au fédéral ?

1675 FOIS PARTAGÉ

RÉACTIONS



An example of adversarial regulation for cooperative microgrids

PROJET D'ARRÊTÉ DU GOUVERNEMENT WALLON RELATIF AUX RÉSEAUX FERMÉS PROFESSIONNELS DE GAZ ET D'ÉLECTRICITÉ

Le Gouvernement wallon,

Vu le décret du 12 avril 2001 relatif à l'organisation du marché régional de l'électricité,
l'article 15ter inséré par le décret 11 avril 2014 ;

Vu le décret du 19 décembre 2002 relatif
16ter inséré par le décret 21 mai 2015 ;

Art. 4. Le demandeur fournit à la CWaPE la justification de la mise en œuvre et l'exploitation d'un réseau fermé professionnel au moyen d'une note reprenant sa situation, notamment géographique, et les arguments permettant d'attester que le réseau fermé professionnel correspond à l'une des conditions suivantes :

- 1° les raisons spécifiques ayant trait à la **technique ou à la sécurité** qui imposent que les opérations ou le processus de production des utilisateurs de ce réseau sont intégrés. Dans ce cas, le demandeur doit démontrer que, au contraire d'un raccordement au réseau public, le réseau fermé professionnel est techniquement nécessaire pour répondre aux exigences de cette intégration ;
- 2° l'électricité ou le gaz est fourni essentiellement pour la consommation propre du propriétaire ou du gestionnaire du réseau fermé professionnel ou aux entreprises liées, ce qui correspond au moins à 90 % des quantités d'électricité ou de gaz consommées sur le site.

The Merygrid project: a cooperative microgrid



The Engis project: integrated industrial processes for energy efficiency

